

# Batting Practice Catalog

<b>Portable Batting Cages .....</b>	<b>2-11</b>
<b>Batting Cage Collars.....</b>	<b>12-13</b>
<b>Infield Protectors.....</b>	<b>13-17</b>
<b>Batting Practice Mats.....</b>	<b>18</b>
<b>Batting Cage/Batting Tunnel Protectors .....</b>	<b>11 &amp; 22</b>
<b>Batting Tunnels.....</b>	<b>19-35</b>
<b>Designated Hitter.....</b>	<b>36</b>
<b>Pitching Machines .....</b>	<b>37-64</b>
<b>Protective Screens .....</b>	<b>65-80</b>
<b>Practice Balls .....</b>	<b>81-82</b>
<b>Batting Tees.....</b>	<b>83-87</b>
<b>Ball Basket, Buckets, Pouch, &amp; Carts.....</b>	<b>56,67-68</b>
<b>Synthetic Turf for Batting Tunnels.....</b>	<b>88</b>

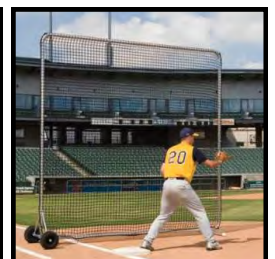
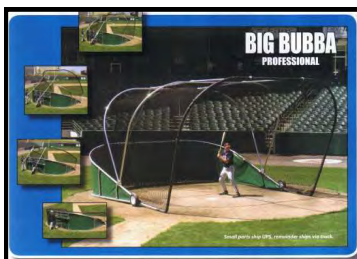
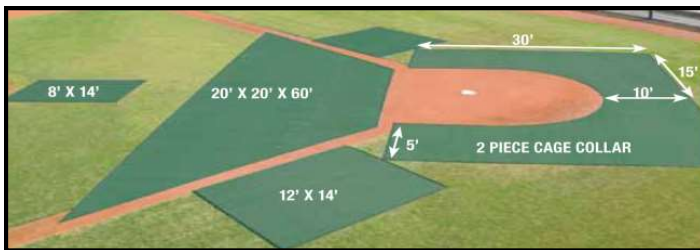

**YOUR "ONE-STOP" SOURCE FOR AMERICA'S BASEBALL, SOFTBALL & SPORTS SURFACES & SUPPLIES!**

PRICES SUBJECT TO CHANGE & AVAILABILITY PLUS SHIPPING | VOLUME DISCOUNTS AVAILABLE | COOPERATIVE PURCHASING CONTRACT PRICING FOR 50 STATES

# BEAM CLAY®

Batting Practice - Jaypro Big League Batting Cages

WHOLESALE PRICE LIST  
 EFFECTIVE: APRIL 23, 2021



## BUY A BETTER CAGE

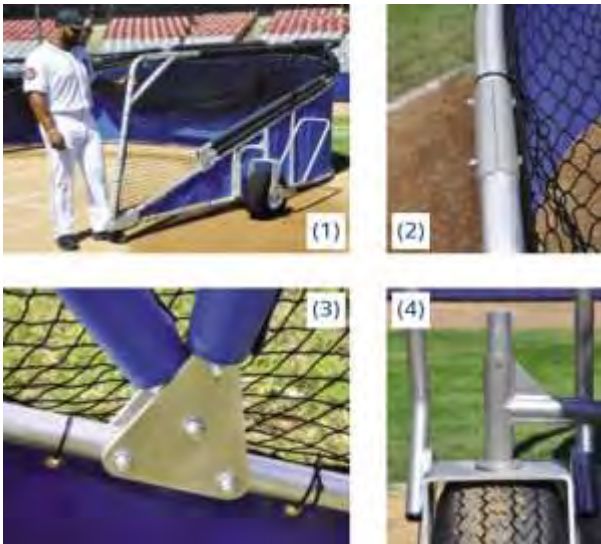

### Jaypro's swivel wheel allows for a more precise cage placement!

- (1) The addition of handle wheels controls the cage height over uneven surfaces, which allows for additional leverage to lift and raise the cage. Reduces cage drag and divots while in motion.
  - (2) Includes joint reinforcing clamps for added rigidity
  - (3) Through-bolts and locking nut connections only, no allen screws here!
  - (4) 18"W x 9"D swivel tires can be adjusted to two different heights that allow movement in multiple directions for easy installation and removal on the playing field
- Fully welded design and pre-assembled side frames make the cage strong and rigid for a long life span
  - Net attaches directly to the frame and has reinforced seams and an integrated baffle

**YOUR "ONE-STOP" SOURCE FOR AMERICA'S BASEBALL, SOFTBALL & SPORTS SURFACES & SUPPLIES!**

PRICES SUBJECT TO CHANGE & AVAILABILITY PLUS SHIPPING | VOLUME DISCOUNTS AVAILABLE | COOPERATIVE PURCHASING CONTRACT PRICING FOR 50 STATES

# Big League Bomber Portable All Star Batting Cage

## Bomber All-Star

Heavy-duty portable batting cage with swivel side wheels and handles allows for easy transport in any direction.

- 2" heavy-wall aluminum tube design
- #42 weather-treated nylon net with rear net baffle
- Thud pad, 18 oz. vinyl skirt, oversized swivel tires with handles, and black ricochet padding on frame with dual observation platforms
- Open Inside Dimensions — 18'W x 12'H x 22'D
- Folded Outside Dimensions — 20'W x 6'H x 15'D
- Thud Pad - 6'W x 4'H x 4"D (Specify skirt and thud pad colors when ordering.)
- 7 Year Limited Warranty
- Ships via common carrier
- Made in the USA

<b>BMR-1RB</b>	Royal Blue, 560 lbs.	<b>\$5,296</b>
<b>BMR-1BK</b>	Black, 560 lbs.	<b>\$5,296</b>
<b>BMR-1RD</b>	Red, 560 lbs.	<b>\$5,296</b>
<b>BMR-1GR</b>	Green, 560 lbs.	<b>\$5,296</b>
<b>BMR-1NB</b>	Navy Blue, 560 lbs.	<b>\$5,296</b>
<b>BMR-1MR</b>	Maroon, 560 lbs.	<b>\$5,296</b>
<b>SKT-LOGO</b>	GRAPHIC PANEL—Batting Cage Thud Pad Removable Graphics Cover-5½' wide graphic	<b>\$282</b>

**SKIRT & PAD COLORS:**



**BMR-1RB** shown with ricochet padding upgrade kit (**RPAD-UKITRB**)



**RICOCHET PADDING UPGRADE KIT**

- Hook-and-loop vinyl attachment that wraps around foam padding
- Kit contains (21) 6 foot lengths
  - 1 Year Limited Warranty
- Specify vinyl color when ordering.*

<b>RPAD-UKITXX</b>	<b>\$297</b>
--------------------	--------------

Replacement Parts		
<b>SKT-75XX</b>	Skirt, 17 lbs	<b>\$509</b>
<b>BLN-3</b>	Net, 44 lbs	<b>\$739</b>
<b>THUD-46XX</b>	Thud Pad, 20 lbs	<b>\$428</b>



Easily bring down the Cage to get ready for Transport



Strong Struts Won't Slip



Rear Wheel & Dual Coaches Stand



Swivel Tires with Handles



Folded Outside Dimensions — 20'W x 6'H x 15'D



Thud Pad and Rear Net Baffle

**YOUR "ONE-STOP" SOURCE FOR AMERICA'S BASEBALL, SOFTBALL & SPORTS SURFACES & SUPPLIES!**

PRICES SUBJECT TO CHANGE & AVAILABILITY PLUS SHIPPING | VOLUME DISCOUNTS AVAILABLE | COOPERATIVE PURCHASING CONTRACT PRICING FOR 50 STATES

# BEAM CLAY®

WHOLESALE PRICE LIST  
EFFECTIVE: JULY 1, 2021

Batting Practice - Jaypro Bomber Elite Batting Cage

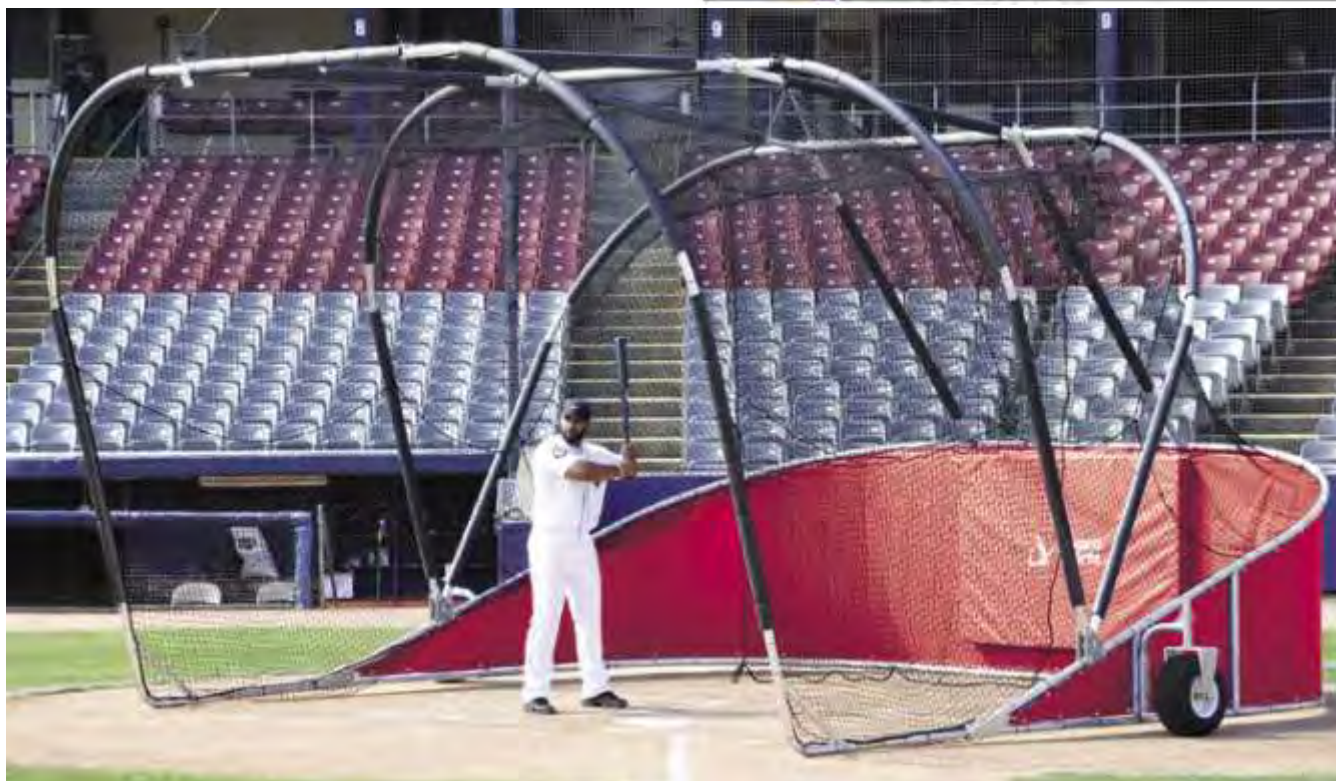

## BOMBER ELITE

Heavy-duty portable batting cage with side wheels that can be rotated and pinned 90°. Two height settings for added clearance during transport.

- 2" heavy-wall aluminum tube design with fully welded side frames
- #42 weather-treated nylon net with rear net baffle
- Thud pad, 18 oz. vinyl skirt, and black ricochet padding on frame with dual observation platforms
- Open Inside Dimensions - 12'H x 18'W x 22'D
- Folded Outside Dimensions - 6'H x 20'W x 15'D
- Thud Pad - 4'H x 6'W x 4"D
- 7 Year Limited Warranty
- Ships via common carrier
- Made in the USA

<b>BGLC-7500RB</b>	Royal Blue, 546 lbs.	<b>\$4,641/EA</b>
<b>BGLC-7500BK</b>	Black, 546 lbs.	<b>\$4,641/EA</b>
<b>BGLC-7500RD</b>	Red, 546 lbs.	<b>\$4,641/EA</b>
<b>BGLC-7500GR</b>	Green, 546 lbs.	<b>\$4,641/EA</b>
<b>BGLC-7500NB</b>	Navy Blue, 546 lbs.	<b>\$4,641/EA</b>
<b>BGLC-7500MR</b>	Maroon, 546 lbs.	<b>\$4,641/EA</b>

### SKIRT & PAD COLORS:

-  ROYAL BLUE
-  BLACK
-  RED
-  GREEN
-  NAVY BLUE
-  MAROON



18"W x 9"D Oversized Turf-Friendly Tires



Strut Storage and Dual Coaches Stand

### RICOCHET PADDING UPGRADE KIT

Hook-and-loop vinyl attachment that wraps around foam padding

- Kit contains (21) 6 foot lengths
- 1 Year Limited Warranty

*Specify vinyl color when ordering.*

<b>RPAD-UKITXX</b>	<b>\$297</b>
--------------------	--------------

REPLACEMENT PARTS		
<b>SKT-75XX</b>	Skirt, 17 lbs	<b>\$509</b>
<b>BLN-3</b>	Net, 44 lbs	<b>\$739</b>
<b>THUD-46XX</b>	Thud Pad, 20 lbs	<b>\$428</b>

**YOUR "ONE-STOP" SOURCE FOR AMERICA'S BASEBALL, SOFTBALL & SPORTS SURFACES & SUPPLIES!**

PRICES SUBJECT TO CHANGE & AVAILABILITY PLUS SHIPPING | VOLUME DISCOUNTS AVAILABLE | COOPERATIVE PURCHASING CONTRACT PRICING FOR 50 STATES

# BEAM CLAY®

WHOLESALE PRICE LIST  
EFFECTIVE: JULY 1, 2021

Batting Practice - Jaypro Bomber Pro Batting Cage

## BIG LEAGUE SERIES



BBGS-18RB

### BOMBER PRO

Heavy-duty portable batting cage for spring training camps, semi-professional, and collegiate use.

- 2" heavy wall aluminum tube design
- #42 weather-treated nylon net with rear net baffle
- 18 oz. vinyl skirt, oversized pneumatic tires, and black ricochet padding on frame
- Observation platform (CVS-10) sold separately
- Open Inside Dimensions - 18'W x 12'H x 22'D
- Folded Outside Dimensions - 20'W x 6'H x 15'D
- Specify skirt colors when ordering.
- 5 Year Limited Warranty
- Ships via common carrier
- Made in the USA



<b>BBGS-18RB</b>	Royal Blue, 505 lbs.	<b>\$4,082/EA</b>
<b>BBGS-18BK</b>	Black, 505 lbs.	<b>\$4,082/EA</b>
<b>BBGS-18RD</b>	Red, 505 lbs.	<b>\$4,082/EA</b>
<b>BBGS-18GR</b>	Green, 505 lbs.	<b>CALL</b>
<b>BBGS-18NB</b>	Navy Blue, 505 lbs.	<b>\$4,082/EA</b>
<b>BBGS-18MR</b>	Maroon, 505 lbs.	<b>\$4,082/EA</b>

### SKIRT & PAD COLORS:

-  ROYAL BLUE
-  BLACK
-  RED
-  GREEN
-  NAVY BLUE
-  MAROON

### REPLACEMENT PARTS

Specify skirt and thud pad color when ordering.

<b>SKT-75XX</b>	Skirt, 17 lbs	<b>\$509/EA</b>
<b>BLN-3</b>	18' x 22' x 12' Net, 44 lbs	<b>\$739/EA</b>
<b>THUD-46XX</b>	Thud Pad, 20 lbs	<b>\$428/EA</b>
<b>CVS-10</b>	Viewing Stand, 24 lbs	<b>\$565/EA</b>
<b>BGLC-75STRUTS</b>	Struts (set of 6)	<b>\$467/SET</b>
<b>BPD-6</b>	Ricochet Cushion Black - 6' lengths, 2 lbs	<b>\$28/EA</b>
<b>PDT-3</b>	Weather Resistant Tape 60 yd. rolls, 2 lbs	<b>\$76/EA</b>

### GRAPHIC PANEL

Batting Cage Thud Pad Removable Graphics Cover-5½' wide graphic

<b>SKT-LOGO</b>	GRAPHIC PANEL	<b>\$282/EA</b>
-----------------	---------------	-----------------



**YOUR "ONE-STOP" SOURCE FOR AMERICA'S BASEBALL, SOFTBALL & SPORTS SURFACES & SUPPLIES!**

PRICES SUBJECT TO CHANGE & AVAILABILITY PLUS SHIPPING | VOLUME DISCOUNTS AVAILABLE | COOPERATIVE PURCHASING CONTRACT PRICING FOR 50 STATES

# BEAM CLAY®

**WHOLESALE PRICE LIST**  
 EFFECTIVE: JULY 1, 2021

Batting Practice - Jaypro Bomber Batting Cage



BOMBER		
Heavy-duty portable batting cage for high school and collegiate training.		
<ul style="list-style-type: none"> <li>• 2" heavy-wall aluminum tube design</li> <li>• #42 weather-treated nylon net with rear net baffle</li> <li>• Heavy-duty tires and black ricochet cushion on frame</li> <li>• Folds down for convenient storage</li> <li>• Optional viewing stand (CVS-10) and vinyl skirt (SKT-20XX) sold separately</li> <li>• 17'6"W x 12'H x 12'D</li> <li>• Ships via common carrier</li> <li>• Made in the USA</li> <li>• 5 Year Limited Warranty</li> </ul>		
<b>BBLs-12</b>	Cage, 410 lbs	<b>\$3,858/EA</b>

**OPTIONAL SKIRT COLORS:**



Royal Blue (RB)



Red (RD)



Green (GR)



Navy Blue (NB)

REPLACEMENT PARTS		
<i>Specify skirt and thud pad color when ordering.</i>		
<b>SKT-20XX</b>	Skirt, 17 lbs	<b>\$420/EA</b>
<b>CVS-10</b>	Viewing Stand, 24 lbs	<b>\$565/EA</b>
<b>LSN-2</b>	Replacement Net, 22 lbs.	<b>\$800/EA</b>
<b>BPD-6</b>	Ricochet Cushion Black - 6' lengths, 2 lbs	<b>\$28/EA</b>
<b>PDT-3</b>	Weather Resistant Tape 60 yd. rolls, 2 lbs	<b>\$76/EA</b>



BBLs-12 with green skirt

**YOUR "ONE-STOP" SOURCE FOR AMERICA'S BASEBALL, SOFTBALL & SPORTS SURFACES & SUPPLIES!**

PRICES SUBJECT TO CHANGE & AVAILABILITY PLUS SHIPPING | VOLUME DISCOUNTS AVAILABLE | COOPERATIVE PURCHASING CONTRACT PRICING FOR 50 STATES

# BEAM CLAY®

## WHOLESALE PRICE LIST EFFECTIVE: JULY 1, 2021

### Batting Practice - Line Drive Batting Cage



LINE DRIVE		
<b>LINE DRIVE</b> Portable and foldable batting cage for high school.		
<ul style="list-style-type: none"> <li>• 2" flo-coated galvanized steel</li> <li>• Powder coated green</li> <li>• #42 knotless nylon weather-treated net with rear net baffle</li> <li>• 16" pneumatic wheels</li> <li>• Rear tire swivels for easy mobility</li> <li>• Folds down to 48"H for convenient storage</li> <li>• 12'H x 16'6"W x 16'6"D</li> <li>• 5 Year Limited Warranty</li> </ul>		
<b>BBLD-5000</b>	CAGE	<b>\$3,767/EA</b>

LINE DRIVE CAGE NET		
<b>LINE DRIVE CAGE NET</b> Replacement net for the Line Drive Batting Cage.		
<ul style="list-style-type: none"> <li>• 16'6"W x 12'H x 16'6"D</li> <li>• 1 Year Limited Warranty, Made in the USA</li> </ul>		
<b>LDN-5</b>	34 lbs	<b>\$593/EA</b>



BATTING CAGE SUN CANOPY	
<ul style="list-style-type: none"> <li>• 25'6"L x 6'W with hemmed perimeter and grommets</li> <li>• Made from 8.2 oz./sq. yd. PVC coated polyester wind screen</li> <li>• Lacing and ties included for attachment</li> <li>• 1 Year Limited Warranty</li> </ul>	
<b>BBBCSC</b>	<b>\$318/EA</b>

**YOUR "ONE-STOP" SOURCE FOR AMERICA'S BASEBALL, SOFTBALL & SPORTS SURFACES & SUPPLIES!**

PRICES SUBJECT TO CHANGE & AVAILABILITY PLUS SHIPPING | VOLUME DISCOUNTS AVAILABLE | COOPERATIVE PURCHASING CONTRACT PRICING FOR 50 STATES

# BEAM CLAY®

WHOLESALE PRICE LIST  
EFFECTIVE: JULY 1, 2021

Batting Practice - Bubba Elite Batting Cage

**8" WIDE X 18" DIAMETER WHEELS FOR EASY TRANSPORT**

**NEW DESIGN LIFTING/STEERING DOLLY**

**DOUBLE COACHES**

**BAFFLE NET AND 4" THICK THUD PAD**

**BUBBA ELITE PORTABLE/COLLAPSIBLE BATTING CAGE**  
*the ultimate portable batting cage*

**FREE DOUBLE NETTING BEHIND BATTER!**

**VINYL SKIRT NOW COMES IN 5 COLORS!**  
Black Navy Royal Red Green

**24 HOUR QUICK SHIP**

**COLLAPSES DOWN TO 5' TALL**

**RICOCHET PADDING ON ALL OVERHEAD FRAMES**

The top choice of Professional, Collegiate and Varsity baseball programs with larger wheels, 2 observation platforms, thud pad and ricochet padding on most frame work.

Frame is 2" heavy wall aluminum tubing that easily and quickly collapses down to 5' high for transport and storage. Includes heavy duty 3.5 mm weather treated EHT netting, plus 10' x 10' baffle net, 4" thick thud pad and 18 oz. vinyl skirt. Three 8-1/2" wide x 18" diameter pneumatic wheels and newly designed lifting/steering locking mechanism makes this the easiest cage to transport and maneuver. Overhead arched frames are all protected with ricochet padding to minimize ball rebound and reduce damage to the frame. Size is 18' wide x 22' deep x 12' high. Weight 600 lbs. **5-Year Limited Warranty.**

**BUBBA ELITE PORTABLE/COLLAPSIBLE BATTING CAGE**

#BSELITE

CALL FOR DISCOUNTED PRICE

\$5,590

**BUBBA ELITE REPLACEMENT NET - 3.5MM WEATHER-TREATED EHT** Includes net w/baffle net.

#BSBNT

\$1,140/EA

**BUBBA ELITE REPLACEMENT 18 OZ. SOLID VINYL COATED NYLON SKIRT - BLACK, NAVY, ROYAL, RED, GREEN**

#BSBSK

\$295/EA

**BUBBA ELITE REPLACEMENT 20 OZ. VINYL MESH SKIRT - BLACK, NAVY, ROYAL, RED, GREEN**

#1300574

\$285/EA

**24" HIGH LETTERS, 1 COLOR #1COL24**

\$55/EA

**BUBBA ELITE REPLACEMENT BLACK BACKSTOP THUD PAD - 68" W x 52" H x 4" thick, goes behind baffle net against skirt.**

#1217612DS

\$325/EA

**BUBBA ELITE REPLACEMENT DOLLEY**

#1316681

\$615/EA

**BUBBA ELITE REPLACEMENT RICOCHET CUSHION PADDING - To cover & protect 2" aluminum tubing, 6' length**

#1273830

\$48/EA

**OPTIONAL FOAM PADDING IN TEAM COLORS WITH TOUGH SKIN**

8' lengths, pre-slit to fit over frame pipes for ricochet protection. Secure with tie wraps sold separately.

#K15324 (Yellow, Red, Royal, Dark Green, Black, Grey, Purple or Light Blue)

\$38/length

#K13109 (19" long tie wraps in Yellow, Royal, Red, Green, Black, pack of 100)

\$25/pack

**YOUR "ONE-STOP" SOURCE FOR AMERICA'S BASEBALL, SOFTBALL & SPORTS SURFACES & SUPPLIES!**

PRICES SUBJECT TO CHANGE & AVAILABILITY PLUS SHIPPING | VOLUME DISCOUNTS AVAILABLE | COOPERATIVE PURCHASING CONTRACT PRICING FOR 50 STATES



# BEAM CLAY®

WHOLESALE PRICE LIST  
EFFECTIVE: JULY 1, 2021

Batting Practice - Big Bubba Batting Cage



**CHOOSE FROM  
5 SOLID VINYL  
COLOR SKIRTS  
OR  
20 MESH  
COLOR SKIRTS**

MESH ALLOWS 22% WIND PASSAGE  
LETTERS AND/OR LOGOS CAN BE  
ADDED AT ADDITIONAL COST



**BIG BUBBA PRO PORTABLE/COLLAPSIBLE BATTING CAGE WITH VINYL SKIRT** - The Big Bubba style portable batting cage is the choice of high school, collegiate and professional baseball programs. Includes batting cage, net, vinyl skirt, and baffle net behind batter. Unit constructed of 2" heavy-wall aluminum tubing, heavy-duty 3.5mm weather-treated EHT netting with 10' x 10' Baffle Net, and either 18 oz. solid vinyl nylon skirt available in 4 colors or vinyl mesh skirt available in 20 colors. This heavy-duty construction, easy portability and collapsible design make it the perfect backstop for any level. Folds down to 5' high for storage. Three 16" high x 4" wide pneumatic wheels. Back wheel assembly tilts to elevate rear of cage for easy transport. Features a coaches observation bar and 42' of ricochet padding. **5-Year Limited Warranty.** Dimensions 18'W x 22'D x 12'H. Shipping weight 408 lbs. **Specify Skirt Color.**



REAR DOLLEY



OPTIONAL PORTABLE COACHES VIEWING PLATFORM



OPTIONAL FOAM PADDING IN TEAM COLORS

#BSBUBBA	<b>BIG BUBBA BATTING CAGE</b>	<b>CALL FOR DISCOUNTED PRICE</b>	<b>\$5,070</b>
#BSBSK	<b>REPLACEMENT 18 OZ. SOLID VINYL NYLON SKIRT</b> (Please Specify Skirt Color: Green, Navy, Red, or Royal)		<b>\$295/EA</b>
#1300574	<b>REPLACEMENT 20 OZ. VINYL MESH SKIRT</b> (Specify Color)		<b>\$285/EA</b>
#1COL24	<b>24" H LETTERS</b>		<b>\$55/EA</b>
#CUSTOM	<b>CUSTOM LOGO</b> (Up to 3' H x 4' W)		<b>Send Logo for Pricing</b>
#K13803	<b>REPLACEMENT NET</b> - Includes net w/baffle net (skirt not included.)		<b>\$1,140/EA</b>
#1150988	<b>OPTIONAL THUD PAD-68" x 52" x 4" thick, Specify Color: Black, Green, Navy, Royal or Red</b>		<b>\$325/EA</b>
#1150988G	<b>THUD PAD WITH GRAPHICS</b>		<b>\$450/EA</b>
#1273830	<b>REPLACEMENT BLACK RICOCHET PADDING, 6' Lengths</b>		<b>\$48/EA</b>
#1274042	<b>REPLACEMENT REAR DOLLEY ASSEMBLY WITH WHEEL</b>		<b>\$615/EA</b>
#K10236	<b>REPLACEMENT SET OF 3 PNEUMATIC WHEELS 4" WIDE x 16" TALL</b> (includes 3 tires mounted on 3 rims)		<b>\$165/EA</b>
#ZX0210004	<b>REPLACEMENT CANOPY LIFTING TUBES WITH HOOKS ON END</b>		<b>\$75/EA</b>
#K73122	<b>OPTIONAL PORTABLE COACHES VIEWING PLATFORM</b>		<b>\$405/EA</b>
#K15324	<b>OPTIONAL FOAM PADDING IN TEAM COLORS WITH TOUGH SKIN</b> 8' lengths, pre-slit to fit over frame pipes for ricochet protection. Secure with tie wraps sold separately.		<b>\$38/length</b>
#K13109	<b>FOAM PADDING:</b> Yellow, Red, Royal, Dark Green, Black, Grey, Purple or Light Blue		<b>\$25/pack</b>
#K13109	<b>19" LONG TIE WRAPS</b> in Yellow, Royal, Red, Green, Black, pack of 100		<b>\$25/pack</b>

**YOUR "ONE-STOP" SOURCE FOR AMERICA'S BASEBALL, SOFTBALL & SPORTS SURFACES & SUPPLIES!**

PRICES SUBJECT TO CHANGE & AVAILABILITY PLUS SHIPPING | VOLUME DISCOUNTS AVAILABLE | COOPERATIVE PURCHASING CONTRACT PRICING FOR 50 STATES

# BEAM CLAY®

Batting Practice - Batting Cages

WHOLESALE PRICE LIST  
EFFECTIVE: JULY 1, 2021



INCLUDES  
NET & REAR  
DOLLEY

**EASY TO SET UP**

**From storage  
to batting  
practice in  
2 minutes!**



OPTIONAL FOAM PADDING  
IN TEAM COLORS



## VARSITY FOLDABLE/PORTABLE BASEBALL BATTING CAGE

**Double netting behind batter!** Frame is 2" O.D. flo-coated 14 gauge steel that folds down to 45" high for storage. Includes heavy duty 3.5mm weather treated EHT net and a 10' x 10' baffle net. Optional 18 oz. vinyl skirt is available in Black. Three 16" high x 4" wide pneumatic wheels. Back wheel assembly tilts to elevate rear of cage for easy transport. Includes 18' of ricochet padding. Size is 16'-6" wide x 16'-6" deep x 11' high. Weight 650 lbs.

#BS4000F	VARSITY BATTING CAGE	\$4,140
#BS4FNET	REPLACEMENT NET	\$1,400
#1274042	REPLACEMENT REAR DOLLEY ASSEMBLY WITH THREE WHEELS	\$615
#1273830	BLACK REPLACEMENT RICOCHET CUSHION PADDING	\$48
<b>OPTIONAL FOAM PADDING IN TEAM COLORS WITH TOUGH SKIN</b> 8' lengths, pre-slit to fit over frame pipes for ricochet protection. Secure with tie wraps sold separately.		
#K15324	FOAM PADDING: Yellow, Red, Royal Blue, Green, Black, Grey, Purple or Sky Blue	\$38/length?
#K13109	19" LONG TIE WRAPS in Yellow, Red, Green, Black, pack of 100	\$25/pack

**YOUR "ONE-STOP" SOURCE FOR AMERICA'S BASEBALL, SOFTBALL & SPORTS SURFACES & SUPPLIES!**

PRICES SUBJECT TO CHANGE & AVAILABILITY PLUS SHIPPING | VOLUME DISCOUNTS AVAILABLE | COOPERATIVE PURCHASING CONTRACT PRICING FOR 50 STATES

**PARTAC PEAT CORPORATION**  
ONE KELSEY PARK, GREAT MEADOWS, NEW JERSEY 07838

800-247-BEAM (2326) • (908) 637-4191 • FAX (908) 637-8421  
www.beamclay.com • sales@beamclay.com  
Bid Term - 5/9/18 - 5/8/20; Extended to 5/8/21; Extended to 5/8/22

# BEAM CLAY®

Batting Practice - Batting Cages

**WHOLESALE PRICE LIST**  
 EFFECTIVE: JULY 1, 2021



## **VARSIY OVERSIZE PORTABLE (NOT FOLDABLE) BASEBALL BATTING CAGE**

**Double netting behind batter!** Extra width to accommodate left or right hand hitters without shifting the cage. Three 16" diameter, 6" hub, ball bearing, multi-directional pneumatic wheels. The back wheel features a unique lever device for easy mobility. Constructed of 2" O. D. Flo-coated steel. Heavy duty (3.5mm) weather-treated EHT cage netting. Easy assembly & disassembly. Dimensions Open: 18'W x 12'D x 14'H. Weight: 550 lbs.

#BS4000

\$3,365

### **REPLACEMENT NET**

#BS4NET

\$1,400

### **DOLLEY ASSEMBLY (included above)**

Kit consists of cross braces, fittings, handle, wheel, etc. Everything you need to replace or add a dolley assembly to your portable backstop.

#1274042

\$615

### **RICOCHET BLACK FOAM PADDING - 6' LENGTHS**

To cover & protect 2" steel tubing. (not included above)

#1273830

\$48

**OPTIONAL FOAM PADDING IN TEAM COLORS AVAILABLE**



**MADE IN USA**

## **SANDLOT PORTABLE BACKSTOP**

### **Super Wide—Great for Baseball and Softball**

Constructed of HD 2" OD Flo-Coated steel tubing for strength and portability. Safety side wings rebound foul tips; extend to provide up to 28' of backstop. Wings come complete with ground stakes for anchoring. Completely portable with semi-pneumatic tires. Weather treated nets included.

**COMPLETE UNIT (15'W x 6'D x 11'H, wt. 500 lbs.)**

#BBBSWING

\$2,555

**REPLACEMENT NET FOR BACK AND TOP**

#SNWINGCTDS

\$300

**9'H x 6'W REPLACEMENT NET FOR WINGS (requires two)**

#SNWINGS D

\$160



**BATTING CAGE SAVERS** — Heavy-duty 7'H x 5'W reinforced vinyl to protect the netting in your batting cage or tunnel comes with brass grommets and 4 poly ropes in corners for attachment. 2 models:

**HEAVY-DUTY 22oz.** — Reinforced vinyl tarp. SPECIFY COLOR: Dark Green, Red or Royal Blue with White strike zone area. 10 lbs.

#13153

\$125

**SUPER-DUTY 30 oz.** — Navy Blue w/Yellow target, or Black w/Orange Target

#12003

\$140

For more options, please see page 22.

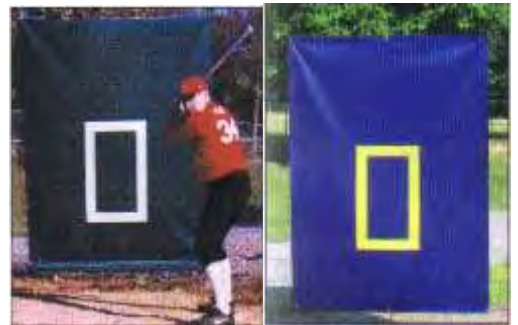

**YOUR "ONE-STOP" SOURCE FOR AMERICA'S BASEBALL, SOFTBALL & SPORTS SURFACES & SUPPLIES!**

PRICES SUBJECT TO CHANGE & AVAILABILITY PLUS SHIPPING | VOLUME DISCOUNTS AVAILABLE | COOPERATIVE PURCHASING CONTRACT PRICING FOR 50 STATES

# BEAM CLAY®

**WHOLESALE PRICE LIST**  
 EFFECTIVE: JULY 1, 2021

Batting Practice - Batting Cage Collars

## 2 PIECE VINYL MESH BATTING CAGE COLLARS

- Extremely Durable Yet Light In Weight
- Lets Grass Breathe
- Resistant to Steel Cleats!
- Heat Sealed & Grommeted Edges

### ARMOR-MESH 2 PIECE CAGE COLLAR WITH 20' BASE LINES (Comes in 14 colors)

Protect your turf during batting practice. Very durable 14 oz. tight weave vinyl coated polyester material will hold up to steel cleat traffic. Edges are heat sealed and grommeted. Available in 13 colors!

**Armor-Mesh Cage Collar #AMCC**  
 Includes 2 piece cage collar only. **\$1,125**  
 (85 lbs. each piece, 170 lbs. total)

**Armor-Mesh Infield Protector #AMIP**  
 15' Deep x 20' x 50' (50 lbs.) **\$515**

**Armor-Mesh Complete Set #AMCS** (220 lbs.)  
 Includes 15' x 20' x 50' trapezoid infield mesh guard & 2 piece cage collar **\$1,530**



#### STANDARD FEATURES

Heat-sealed edges with grommets every 3'-4'.

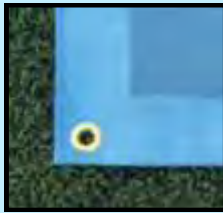

**Available Colors**

Dark Green, Royal Blue, Red, Light Gray, Kelly Green, Maroon, Navy Blue, Black, Purple, Orange, Carolina Blue, Yellow, White

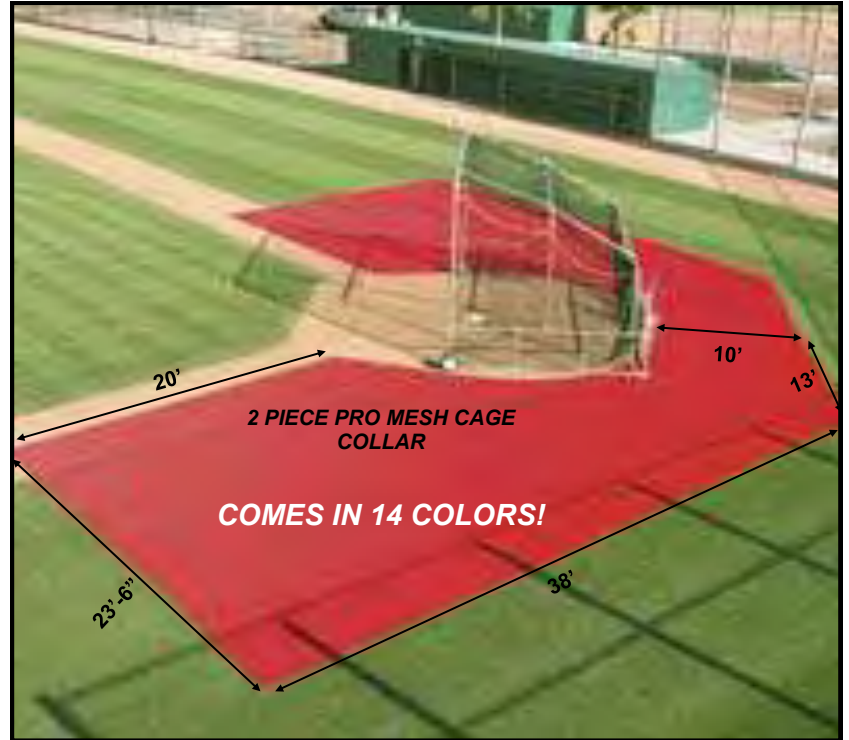

**YOUR "ONE-STOP" SOURCE FOR AMERICA'S BASEBALL, SOFTBALL & SPORTS SURFACES & SUPPLIES!**

PRICES SUBJECT TO CHANGE & AVAILABILITY PLUS SHIPPING | VOLUME DISCOUNTS AVAILABLE | COOPERATIVE PURCHASING CONTRACT PRICING FOR 50 STATES

# BEAM CLAY®

**WHOLESALE PRICE LIST**  
EFFECTIVE: JULY 1, 2021

Batting Practice - Infield Protectors

## VARSITY INFIELD PROTECTOR

Heavy-duty extremely durable 20 mil. VIPOL® Matrix Mesh will stand up to cleats to protect your turf. Comes hemmed and grommeted on edges. Anchor stakes not included, sold separately. Purchase the complete set or individual components. Choose from 23 colors.

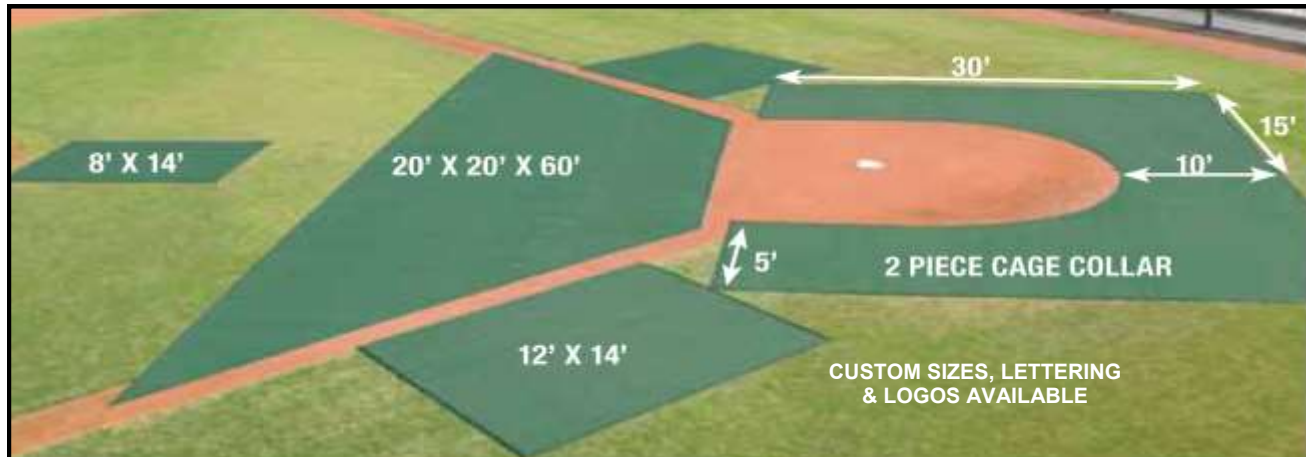

### DELUXE COMPLETE SET #BPZ5PCSET

Includes 8' x 14' pitcher's platform blanket, 20' x 20' x 60' trapezoid infield guard, 2 piece cage collar and 2 fungo blankets 12' x 14' blankets. Wt. 298 lbs.

**\$1,595**

### INDIVIDUAL COMPONENTS

Trapezoid infield blanket 20' Deep x 20' x 60', Wt. 85 lbs. #BPINFIELDP202060

**\$755**

2 piece cage collar only, based on 30' dia cutout (sq) - U-Shaped, Wt. 82 lbs. #BPCCSQ30

**\$550**

Individual 8' x 14' turf blanket, Wt. 14 lbs. #BPZTM814

**\$125**

Individual 12' x 14' turf blanket, Wt. 20 lbs. #BPZTM1214

**\$175**

Custom Cage Collar #BPCCX

**.96/SF**

Optional 9" ground anchor stakes #JSTAKE

**\$1.25/ea**

Optional 9" ground anchor stakes, pack of 15 #JS15

**\$19.50**

Optional 9" ground anchor stakes, pack of 30 #JS30

**\$35**

Optional 9" ground anchor stakes, pack of 115 #JS115

**\$95**

## CUSTOM SIZES, CHROMA BOND LETTERING & LOGOS AVAILABLE

### VIPOL® MATRIX COLOR CHART

White	Grey	Beige/Tan	Brown	Black	Maroon	Scarlet	Red	Burnt Orange	Orange	Vegas Gold	
Gold	Yellow	Aqua	Kelly Green	Forest Green	Midnight Green	Navy	ProBlue	Royal Blue	CC Sky Blue	Purple	Sport Grey/Charcoal

ACTUAL COLOR OF MATERIALS MAY VARY FROM EACH "LOT" / "RUN".  
IF YOU ARE TRYING TO MATCH A SPECIFIC COLOR, PLEASE REQUEST A SAMPLE FROM THE CURRENT STOCK AVAILABLE FOR PRODUCTION.

**YOUR "ONE-STOP" SOURCE FOR AMERICA'S BASEBALL, SOFTBALL & SPORTS SURFACES & SUPPLIES!**

PRICES SUBJECT TO CHANGE & AVAILABILITY PLUS SHIPPING | VOLUME DISCOUNTS AVAILABLE | COOPERATIVE PURCHASING CONTRACT PRICING FOR 50 STATES

**PARTAC PEAT CORPORATION**  
ONE KELSEY PARK, GREAT MEADOWS, NEW JERSEY 07838

800-247-BEAM (2326) • (908) 637-4191 • FAX (908) 637-8421  
www.beamclay.com • sales@beamclay.com  
Bid Term - 5/9/18 - 5/8/20; Extended to 5/8/21; Extended to 5/8/22

# BEAM CLAY®

**WHOLESALE PRICE LIST**  
 EFFECTIVE: JULY 1, 2021

## Batting Practice - Infield Protectors

### VINYL COATED POLYESTER MESH BATTING PRACTICE INFIELD PROTECTORS

**STANDARD MESH** (9 x 12: 8 oz.) Available in 15 colors.  
 Not for metal cleats. Heat-sealed edges with grommets every 3-4' on all sides.  
 3-year warranty for UV breakdown. Stock sizes below; custom sizes available.

- 15' Deep x 20' Wide x 50' Across (35 lbs.) **#VCPMesh15x20**
- 15' Deep x 26' Wide x 56' Across (44 lbs.) **#VCPMesh15x26**
- 20' Deep x 20' Wide x 60' Across (46 lbs.) **#VCPMesh20x20**
- 20' Deep x 24' Wide x 64' Across (56 lbs.) **#VCPMesh20x24**
- 25' Deep x 20' Wide x 70' Across (65 lbs.) **#VCPMesh25x20**

- \$415
- \$450
- \$520
- \$585
- \$730

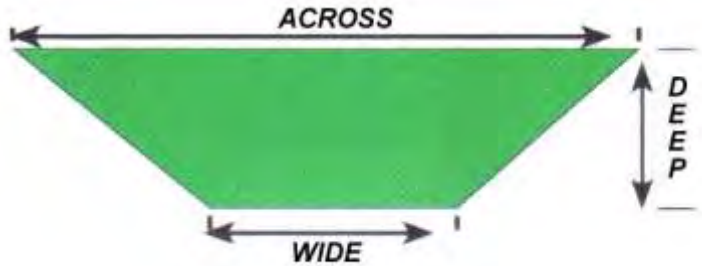

**PREMIUM ARMOR MESH** (VCM 16 x 16: 14 oz.)  
**Excellent resistance to metal cleats!** 13 colors available.  
 Heat-sealed edges with grommets every 3'-4' on all sides.  
 5-Year warranty on UV breakdown.

- 15' Deep x 20' Wide x 50' Across (50 lbs.) **#PAMesh15x20**
- 15' Deep x 26' Wide x 56' Across (59 lbs.) **#PAMesh15x26**
- 20' Deep x 20' Wide x 60' Across (74 lbs.) **#PAMesh20x20**
- 20' Deep x 24' Wide x 64' Across (81 lbs.) **#PAMesh20x24**
- 25' Deep x 20' Wide x 70' Across (104 lbs.) **#PAMesh25x20**

- \$525
- \$570
- \$645
- \$730
- \$925

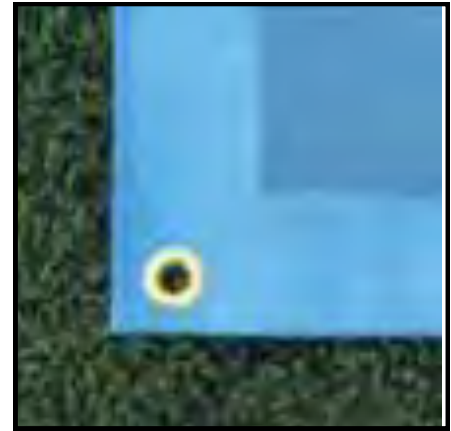

### TENT STAKES

- Steel 1/4" x 9" **#TSSSteel** 95¢/ea.
- Powder Coated Safety Yellow, 1/4" x 9" **#TSPCSY** \$1.75/ea.

### SOD STAPLES, U-SHAPED STEEL 1" x 6"

- Box of 1,000 **#SS/1000** \$75
- Package of 100 **#SS/100** \$25
- Package of 25 **#SS/25** \$10

- WHITE ALUMINUM SPIKES, 1/4" x 7" **#WAS** 95¢/ea.



**WARNING:** If using stakes, staples or spikes, special care must be taken not to leave any on the field which would be a dangerous hazard.

**YOUR "ONE-STOP" SOURCE FOR AMERICA'S BASEBALL, SOFTBALL & SPORTS SURFACES & SUPPLIES!**

PRICES SUBJECT TO CHANGE & AVAILABILITY PLUS SHIPPING | VOLUME DISCOUNTS AVAILABLE | COOPERATIVE PURCHASING CONTRACT PRICING FOR 50 STATES

# BEAM CLAY®

## WHOLESALE PRICE LIST EFFECTIVE: JULY 1, 2021

### Batting Practice - Infield Protectors

#### MESH INFIELD PROTECTORS:

Basic Mesh Fabric is 8 oz. vinyl coated polyester with moderate resistance to metal cleats. 10 oz. Premium VIPOL® Matrix Mesh fabric is extremely durable and will hold up to steel cleat traffic. These infield protectors come with perimeter edges hemmed and grommeted.

**BASIC MESH**—Available in 5 colors shown below.

<b>BPINFIELDB152050</b>	15' Deep x 20' Wide x 50' Across (28 lbs.)	<b>\$440</b>
<b>BPINFIELDB152656</b>	15' Deep x 26' Wide x 56' Across	<b>\$540</b>
<b>BPINFIELDB202060</b>	20' Deep x 20' Wide x 60' Across (46 lbs.)	<b>\$540</b>
<b>BPINFIELDB252070</b>	25' Deep x 20' Wide x 70' Across (69 lbs.)	<b>\$640</b>
<b>BPINFIELDB151848</b>	15' Deep x 18' Wide x 48' Across	<b>\$405</b>
<b>BPINFIELDB152454</b>	15' Deep x 24' Wide x 54' Across	<b>\$515</b>
<b>BPINFIELDB202464</b>	20' Deep x 24' Wide x 64' Across	<b>\$630</b>
<b>BPINFIELDBX</b>	Custom Size	<b>984/SF</b>

**PREMIUM VIPOL® MATRIX**—Available in 23 colors shown below.

<b>BPINFIELDP152050</b>	15' Deep x 20' Wide x 50' Across (48 lbs.)	<b>\$595</b>
<b>BPINFIELDP202060</b>	20' Deep x 20' Wide x 60' Across (83 lbs.)	<b>\$755</b>
<b>BPINFIELDP252070</b>	25' Deep x 20' Wide x 70' Across (106lbs.)	<b>\$915</b>
<b>BPINFIELDP151848</b>	15' Deep x 18' Wide x 48' Across	<b>\$545</b>
<b>BPINFIELDP152454</b>	15' Deep x 24' Wide x 54' Across	<b>\$700</b>
<b>BPINFIELDP202464</b>	20' Deep x 24' Wide x 64' Across	<b>\$890</b>
<b>BPINFIELDPX</b>	Custom Size	<b>984/SF</b>

**WIND WEIGHTED PREMIUM VIPOL® MATRIX**—Same as our Premium Mesh above with the addition of weighted edges. No stakes or sand bags required. Use on natural or synthetic turf.

<b>WWBPINFIELDP152050</b>	15' Deep x 20' Wide x 50' Across (95 lbs.)	<b>\$730</b>
<b>WWBPINFIELDP202060</b>	20' Deep x 20' Wide x 60' Across (120 lbs.)	<b>\$895</b>
<b>WWBPINFIELDP252070</b>	25' Deep x 20' Wide x 70' Across (150 lbs.)	<b>\$1,185</b>
<b>WWBPINFIELDP151848</b>	15' Deep x 18' Wide x 48' Across	<b>\$685</b>
<b>WWBPINFIELDP152454</b>	15' Deep x 24' Wide x 54' Across	<b>\$815</b>
<b>WWBPINFIELDP202464</b>	20' Deep x 24' Wide x 64' Across	<b>\$1,010</b>
<b>WWBPINFIELDPX</b>	Custom Size	<b>\$2.60/SF</b>

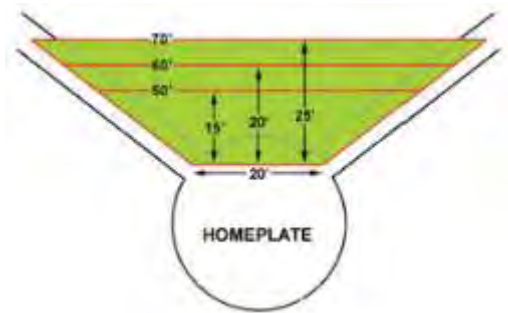

AVAILABLE WITH WIND WEIGHTED EDGES!  
CUSTOM SIZES,  
CHROMA BOND LETTERING & LOGOS AVAILABLE.

#### BASIC MESH -VCP COLOR CHART

Green	Red	Royal Blue	Yellow	Black
-------	-----	------------	--------	-------

#### VIPOL® MATRIX COLOR CHART

White	Grey	Beige/Tan	Brown	Black	Maroon	Scarlet	Red	Burnt Orange	Orange	Vegas Gold	
Gold	Yellow	Aqua	Kelly Green	Forest Green	Midnight Green	Navy	ProBlue	Royal Blue	CC Sky Blue	Purple	Sport Grey/ Charcoal

ACTUAL COLOR OF MATERIALS MAY VARY FROM EACH "LOT" / "RUN".  
IF YOU ARE TRYING TO MATCH A SPECIFIC COLOR, PLEASE REQUEST A SAMPLE FROM THE CURRENT STOCK AVAILABLE FOR PRODUCTION.

**YOUR "ONE-STOP" SOURCE FOR AMERICA'S BASEBALL, SOFTBALL & SPORTS SURFACES & SUPPLIES!**

PRICES SUBJECT TO CHANGE & AVAILABILITY PLUS SHIPPING | VOLUME DISCOUNTS AVAILABLE | COOPERATIVE PURCHASING CONTRACT PRICING FOR 50 STATES

# BEAM CLAY®

Chroma Bond Imprinting

**WHOLESALE PRICE LIST**  
EFFECTIVE: JULY 1, 2021

## CHROMA-BOND IMPRINTING

Chroma-Bond Imprinting, 1 Color Logo Only

<b>1COL25SF</b>	Up to 25SF	\$550/EA
<b>1COL2650SF</b>	26SF—50SF	\$725/EA
<b>1COL51100SF</b>	51SF-100SF	\$995/EA

Chroma-Bond Imprinting, 2 Color Logo Only

<b>2COL25SF</b>	Up to 25SF	\$675/EA
<b>2COL2650SF</b>	26SF—50SF	\$850/EA
<b>2COL51100SF</b>	51SF-100SF	\$1,150/EA

Chroma-Bond Imprinting, 3 Color Logo Only

<b>3COL25SF</b>	Up to 25SF	\$760/EA
<b>3COL2650SF</b>	26SF—50SF	\$925/EA
<b>3COL51100SF</b>	51SF-100SF	\$1,215/EA

Chroma-Bond Imprinting  
Letters or Numbers

	1 Color	Up to 24" Tall	2 Color
<b>1COL24</b>	\$56/EA.		<b>2COL24</b> \$76/EA
<b>1COL36</b>	\$68/EA	36" Tall	<b>2COL36</b> \$88/EA
<b>1COL48</b>	\$84/EA	48" Tall	<b>2COL48</b> \$104/EA
<b>1COL60</b>	\$98/EA	60" Tall	<b>2COL60</b> \$118/EA
<b>1COL72</b>	\$120/EA	72" Tall	<b>2COL72</b> \$139/EA
<b>1COL84</b>	\$131/EA	84" Tall	<b>2COL84</b> \$151/EA
<b>1COL96</b>	\$150/EA	96" Tall	<b>2COL96</b> \$171/EA
<b>1COL108</b>	\$178/EA	108" Tall	<b>2COL108</b> \$198/EA
<b>1COL120</b>	\$206/EA	120" Tall	<b>2COL120</b> \$226/EA



Our sharp multi-color images will outlast other processes. Eliminates the historic problems of digital printing, like weathering, premature fading, scuffing, and unsightly white mesh backside color. Images will last outdoors as long as the fabric, something rarely true with digital imprinting. Also highly spike, cleat, and racquet resistant. Our thick, individually-applied, double coating process literally bonds the image into the vinyl and completely masks the underlying fabric color, so image colors are vivid and true.

**Chroma-Bond** imprinting is available on our vinyl-surfaced windscreens, cover, padding & sign products.



PRICES SUBJECT TO CHANGE & AVAILABILITY PLUS SHIPPING | VOLUME DISCOUNTS AVAILABLE | COOPERATIVE PURCHASING CONTRACT PRICING FOR 50 STATES



**BEAM CLAY®**

Batting Practice - Infield Protectors

**WHOLESALE PRICE LIST**  
 EFFECTIVE: JULY 1, 2021

# BUNT ZONE™

## INFIELD PROTECTOR TRAINER

Color coded bunting/hitting targets built-in.

### MAJOR LEAGUE



### STANDARD

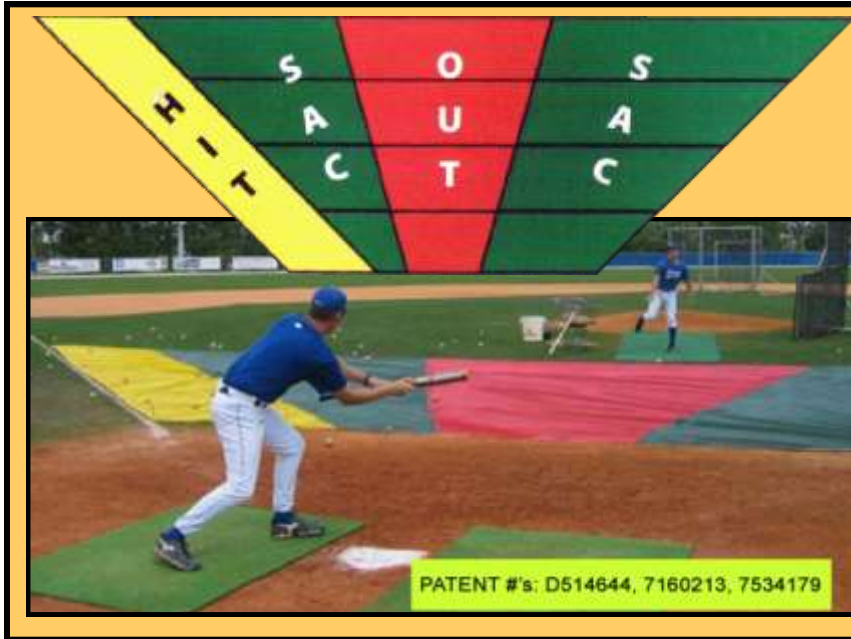

Saves turf and teaches by visualization the correct placement of bunts for hit (yellow) or sacrifice (green). Avoid red area for bunting, hit-and-run, and pull-hitting, but go to it for up-the-middle hitting. Highly spike-tolerant 9 oz. industrial vinyl-polyester mesh with UV and mildew inhibitors. Fusion welded seams and full perimeter, double stitched, webbing-reinforced hem with 10 grommets installed. Includes low profile ground stakes.

#### STANDARD STYLE (Yellow on 3rd base side only.)

<b>LARGE:</b> 20' Deep x 24' x 64', Wt. 57 lbs.	<b>BUNTZNMNRLG</b>	<b>\$775</b>
<b>MEDIUM:</b> 15' Deep x 24' x 54', 45 lbs	<b>BUNTZNMNRLMED</b>	<b>\$670</b>
<b>LITTLE LEAGUE/SOFTBALL:</b> 15' Deep x 18' x 48', 38 lbs	<b>BUNTZNMNRSM</b>	<b>\$580</b>

#### MAJOR LEAGUE STYLE (Yellow on 1st & 3rd base sides.)

<b>LARGE:</b> 20' Deep x 24' x 64', Wt. 57 lbs.	<b>BUNTZNMLLG</b>	<b>\$840</b>
<b>MEDIUM:</b> 15' Deep x 24' x 54', 45 lbs	<b>BUNTZNMLMED</b>	<b>\$735</b>
<b>LITTLE LEAGUE/SOFTBALL:</b> 15' Deep x 18' x 48', 38 lbs	<b>BUNTZNMLSM</b>	<b>\$635</b>

**YOUR "ONE-STOP" SOURCE FOR AMERICA'S BASEBALL, SOFTBALL & SPORTS SURFACES & SUPPLIES!**

PRICES SUBJECT TO CHANGE & AVAILABILITY PLUS SHIPPING | VOLUME DISCOUNTS AVAILABLE | COOPERATIVE PURCHASING CONTRACT PRICING FOR 50 STATES

**PARTAC PEAT CORPORATION**  
 ONE KELSEY PARK, GREAT MEADOWS, NEW JERSEY 07838

800-247-BEAM (2326) • (908) 637-4191 • FAX (908) 637-8421  
 www.beamclay.com • sales@beamclay.com  
 Bid Term - 5/9/18 - 5/8/20; Extended to 5/8/21; Extended to 5/8/22

# BEAM CLAY®

## WHOLESALE PRICE LIST EFFECTIVE: JANUARY 1, 2021

### Artificial / Synthetic Turf - Batting Practice Mats

#### BATTING PRACTICE MATS

Artificial turf mats, **PREMIUM GRADE 36 OZ. PILE**, 100% polypropylene with 5mm foam-rubber backing. These 3/4" thick padded mats **stand up to spikes**. Save time and labor. For ideal game conditions, moisten plate and mound areas before pre-game batting practice. Place mats on mound and home plate areas. After batting practice, remove mats to find areas tamped, level and moist for game-ready conditions. Available in Green, Clay, White, Blue, Orange, Yellow, Red, Black, Purple, Crimson, Maroon, Brown & Navy.

Baseball Home Plate (6' x 12') with batter's box lines and home plate both in permanent white turf (75 lbs.)		GREEN COLORS	ST-1P ST-1PC	\$345 \$395
Baseball Home Plate (6' x 12') with permanent white turf batter's box lines - NO PLATE - use with throw down home plate so mat can be rotated (75 lbs.)		GREEN COLORS	ST-1 ST-1C	\$315 \$355
Baseball/Softball Home Plate (7' x 12') with 4' x 7' permanent white turf batter's box lines (not 3' x 7') and Home Plate (85 lbs.)		GREEN COLORS	ST-712P ST-712PC	\$425 \$465
Baseball/Softball Home Plate (7' x 12') with 4' x 7' permanent white turf batter's box lines (not 3' x 7') NO PLATE—use with throw down home plate so mat can be rotated (85 lbs.)		GREEN COLORS	ST-712P-1 ST-712PC-1	\$385 \$415
Softball Home Plate (7' x 12') Plain (85 lbs.)		GREEN COLORS	ST-1SBG ST-1SBC	\$345 \$365
Pitcher's Mat (6' x 12') (75 lbs.)		GREEN COLORS	ST-2G ST-2C	\$325 \$345
Pitcher's Mat (4' x 12') (50 lbs.)		GREEN COLORS	ST-2A-G ST-2A-C	\$245 \$265
Multi-Purpose Mat (4' x 6') (26 lbs.)		GREEN	ST-3	\$160
Multi-Purpose Mat (3' x 7') (23 lbs.)		GREEN	ST-3A	\$145
Multi-Purpose Mat (4' x 7') (30 lbs.)		GREEN	ST-3B	\$175
Multi-Purpose Mat (6' x 9') (55 lbs.)		GREEN	ST-3C	\$275
Bullpen Mat (12' x 12') Plain (145 lbs.)		GREEN	ST-BPM	\$675
Coaches Box Mat (6' x 12') (75 lbs.)		GREEN	ST-CB1	\$325
Set of 2 On-Deck/Fungo Circles (4' diameter) (15 lbs. EA)		GREEN COLORS	ST-4 ST-4C	\$265 \$285
Set of 2 On-Deck/Fungo Circles (5' diameter) (21 lbs. EA) - Green	GREEN COLORS	ST-5 ST-5C	\$315 \$345	
Set of 2 On-Deck/Fungo Circles (6' diameter) (30 lbs. EA) - Green	GREEN COLORS	ST-6 ST-6C	\$355 \$375	
Logos inset with colored turf are available. Maximum 3 colors - Send artwork for firm quote - <u>price depends on complexity of artwork</u> .			ST-6L	SEND LOGO

**CAUTION:** Artificial turf mats with logos of colored turf sewn into the mat are for decorative or light-duty use at Fungo circles or at on-deck circles not exposed to heavy use.

For more on-deck circle options, see our On-Deck Circle Catalog #102.



**YOUR "ONE-STOP" SOURCE FOR AMERICA'S BASEBALL, SOFTBALL & SPORTS SURFACES & SUPPLIES!**

PRICES SUBJECT TO CHANGE & AVAILABILITY PLUS SHIPPING | VOLUME DISCOUNTS AVAILABLE | COOPERATIVE PURCHASING CONTRACT PRICING FOR 50 STATES

**PARTAC PEAT CORPORATION**  
ONE KELSEY PARK, GREAT MEADOWS, NEW JERSEY 07838

800-247-BEAM (2326) • (908) 637-4191 • FAX (908) 637-8421  
www.beamclay.com • sales@beamclay.com  
Bid Term - 5/9/18 - 5/8/20; Extended to 5/8/21; Extended to 5/8/22

# BEAM CLAY®

**WHOLESALE PRICE LIST**  
EFFECTIVE: JULY 1, 2021

## Batting Practice - Batting Tunnel Frames & Nets

### PROFESSIONAL BATTING TUNNEL FRAMES & NETTING

With our **Professional Batting Tunnel Frame (#66214)** your poles can be set at your desired length (55' | 70' | 75') and can also be adjusted to fit custom net widths. This unique design allows for the tunnel's net to easily be adjusted at any time after the initial installation. This heavy-duty frame is constructed using six 4" square, heavy-duty steel poles. A black, baked on powder coat finish on the steel frame provides the ultimate weather resistance and protection. Frame is reinforced using 13-gauge galvanized steel crossbars to hang the net. Crossbars feature Allied's® zinc Flo-coat galvanization process for maximum protection. System includes everything needed to install and hang net: chain, cables, hooks, collars, ground sleeves and c-snaps. Tunnel net is sold separately. The Professional Batting Tunnel Frame has a 5 Year warranty.



**Professional Double Batting Tunnel Frame (# 66214D)**  
Same high quality materials as the standard Professional Batting Tunnel Frames. These double frames share center poles to allow side-by-side installation, eliminating the need for extra poles and ground footings.

- #66214 55' | 70' | 75' Model, 868 lbs. **\$3,695**
- #66214D Double Model (side-by-side) **\$6,160**

5-Year warranty. System can be adjusted to fit custom net widths and lengths.

Order netting separately.

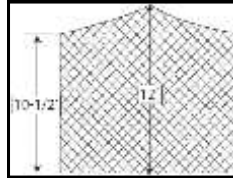

**BATTERS VIEW OF CAGE**  
Note: The "slope" of the net is important. The center of the net for it's entire length is 12' high. The sides of the net are 10-1/2' high, leaving 18" of net on the ground to keep batter balls inside the enclosed area.



### Premium Knotted Braided HDPE Polyethylene Black Tunnel Netting:

Polyethylene netting is more durable and weather, UV, mold and mildew resistant than polypropylene or nylon netting. Knotted netting provides a higher overall strength rating than knotless netting making it superior for direct impact applications.

- \* Tunnel nets are made with 1-3/4" knotted square mesh to reduce sag, for easier installation, and to provide a cleaner appearance.
- \* 5/16" rope border sewn around perimeter.
- \* Corners have 6' rope tails and sewn loops making it easier to hang.
- \* All tunnel nets include a convenient overlap style entry door..
- \* Tunnels can be customized to your size specifications.



- #48 Professional, BT-PRO 3.5** (3.5 mm Knotted; 4 Year Warranty)
- #36033 BT-Pro 3.5 Knotted Braided HDPE Batting Tunnel Net, 12'H x 12'W x 70'L **\$1,305**
  - #36035 BT-Pro 3.5 Knotted Braided HDPE Batting Tunnel Net, 12'H x 14'W x 70'L **\$1,385**
  - #36039 BT-Pro 3.5 Knotted Braided HDPE Batting Tunnel Net, 12'H x 14'W x 75'L **\$1,460**
  - #36038 BT-Pro 3.5 Knotted Braided HDPE Batting Tunnel Net, 12'H x 12'W x 55'L **\$1,000**
  - #36036 BT-Pro 3.5 Knotted Braided HDPE Batting Tunnel Net, 12'H x 14'W x 55'L **\$1,075**

- #42 Collegiate, BT-#42** (3 Year Warranty)
- \* Polyethylene netting is a #42 gauge in with reinforced sewn rope borders around the perimeter.
  - \* Corners have 6' rope tails and sewn loops making it easier to hang.
  - \* Choose from six standard sizes.
  - \* All nets include a convenient overlap style entry door.

- #36042 BT-#42 Knotted Twisted HDPE Batting Tunnel Net, 12'H x 12'W x 35'L **\$460**
- #36048 BT-#42 Knotted Twisted HDPE Batting Tunnel Net, 12'H x 12'W x 55'L **\$615**
- #36046 BT-#42 Knotted Twisted HDPE Batting Tunnel Net, 12'H x 14'W x 55'L **\$745**
- #36043 BT-#42 Knotted Twisted HDPE Batting Tunnel Net, 12'H x 12'W x 70'L **\$770**
- #36045 BT-#42 Knotted Twisted HDPE Batting Tunnel Net, 12'H x 14'W x 70'L **\$845**
- #36049 BT-#42 Knotted Twisted HDPE Batting Tunnel Net, 12'H x 14'W x 75'L **\$920**



**YOUR "ONE-STOP" SOURCE FOR AMERICA'S BASEBALL, SOFTBALL & SPORTS SURFACES & SUPPLIES!**

PRICES SUBJECT TO CHANGE & AVAILABILITY PLUS SHIPPING | VOLUME DISCOUNTS AVAILABLE | COOPERATIVE PURCHASING CONTRACT PRICING FOR 50 STATES

# BEAM CLAY®

**WHOLESALE PRICE LIST**  
EFFECTIVE: JULY 1, 2021

## Batting Practice—Indoor Batting Tunnels/Indoor Ceiling Suspension Kit

### Protective Net Saver or Divider

12'H x 14'W (Item # 36060)  
12'H x 12'W (Item # 36062)  
Our #48 knotted braided polyethylene netting backdrop provides a buffer for your net as a Net Saver behind the batter or as a Net Divider position to create two short toss stations. The durable rope border simplifies installation and reduces sag. Available in black only.

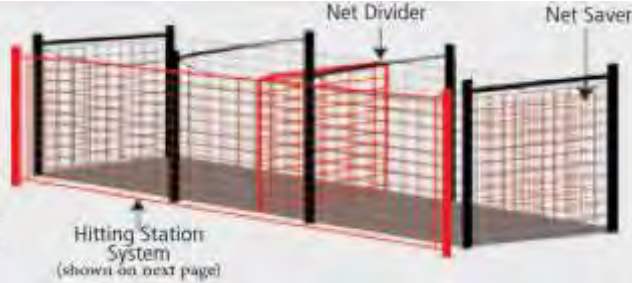

- #36060** Protective Net Saver or Divider, 12'H x 14'W, 9 lbs. **\$116**
- #36062** Protective Net Saver or Divider, 12'H x 12'W, 7 lbs. **\$100**

### Indoor Batting Tunnel Tensioning Kit

(Item # 66200)  
The perfect solution for anyone who wants an indoor batting tunnel but can't install or leave up overhead cables, permanent posts or automated drop down frames. This system is ideal for multi-purpose facilities like gymnasiums, cafeterias, pole buildings, etc. because it sets up, tears down, and stores away in minutes—leaving your space free from any overhead obstructions. Choose your batting tunnel net and add a heavy-duty vinyl floor cover for a complete professional indoor batting tunnel system.

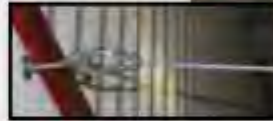

- Tensioning Kit Contains:**
- 6 – Eyebolts
  - 6 – 8 mm Spring Link Clips
  - 6 – 3/8" Spring Link Clips
  - 6 – Cables 15' long
  - 3 – 50' Pieces of High Strength Braided Hoisting Rope 3/8"
  - 3 – Complete Cam Lock Pulley Systems



### Batting Tunnel Floor Covers

15'W x 60'L (Item # 29250)  
15'W x 80'L (Item # 29255)  
Constructed of 20.5 oz/sq. yd. PVC coated polyester vinyl that is anti-mildew and UV coated. Meets California Fire Marshal requirements. Standard Tan in color, 7 Year limited warranty.



### Batting Tunnel Frame Kit without Poles

55' Softball Kit (Item # 66221)  
70'75' Baseball Kit (Item # 66220)  
A Do-it-Yourself Batting Tunnel Kit! Includes all the supplies you need to turn standard 12' long, 3" OD steel into a full size Batting Tunnel. Complete kit includes: Top angle bars, support cables, cable clamps and carabiners. Top angle bars are 2-3/8" OD galvanized steel pipe with a 15 degree bend; providing enough space to properly hang the tunnel net away from the steel posts. The provided Support Cable is 1/4" galvanized steel with a 4200 lb break strength. Batting Tunnel Net and optional ground sleeves are sold separately. Standard 3" OD steel poles are not included.

Kit is for use with 3" OD steel poles

### Indoor Ceiling Suspension Kit

(Item # 66219)  
Includes hardware needed to suspend a batting tunnel net from the ceiling inside a gym or training facility.

- Contains:
- 3 – 100' galvanized wire cables
  - 30 – 30' galvanized wire cables
  - 66 – Wire rope clamps
  - 6 – Hook and eye turnbuckles
  - 6 – Eyebolts
  - 70 – Snap links

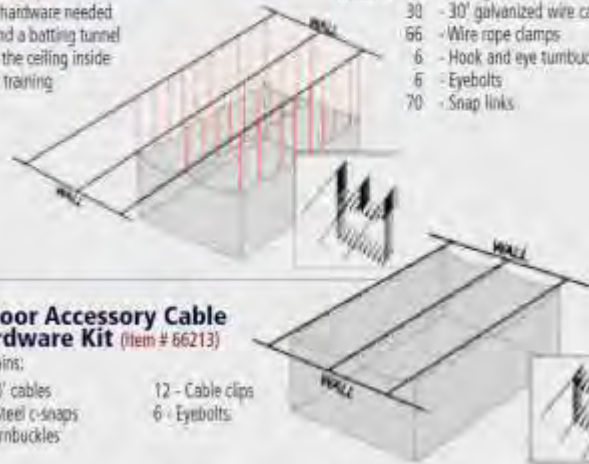

### Indoor Accessory Cable Hardware Kit

- Contains:
- 3-100' cables
  - 50 - Steel c-snaps
  - 6 - Turnbuckles
  - 12 - Cable clips
  - 6 - Eyebolts

- #66200** Indoor Batting Tunnel Tensioning Kit, 30 lbs. **\$1,385**
- #29250** 20.5 oz. Batting Tunnel Floor Covers 15'W x 60'L, Tan, 145 lbs. **\$770**
- #29255** 20.5 oz. Batting Tunnel Floor Covers 15'W x 80'L, Tan, 195 lbs. **\$920**
- #66219** Indoor Ceiling Suspension Kit, 74 lbs. **\$615**
- #66213** Indoor Accessory Cable Hardware Kit, 44 lbs. **\$460**

**YOUR "ONE-STOP" SOURCE FOR AMERICA'S BASEBALL, SOFTBALL & SPORTS SURFACES & SUPPLIES!**

PRICES SUBJECT TO CHANGE & AVAILABILITY PLUS SHIPPING | VOLUME DISCOUNTS AVAILABLE | COOPERATIVE PURCHASING CONTRACT PRICING FOR 50 STATES

# BEAM CLAY®

## WHOLESALE PRICE LIST EFFECTIVE: JULY 1, 2021

Batting Practice - Batting Tunnel Frames & Nets



### Hitting Station Systems—10' High

Great for “soft toss”, tee work and more, the 3-pole shown in red against batting frame of the Hitting Station helps coaches and players get the most out of every practice. This “stand alone” system can be placed along side of your batting tunnel/cage for players to use before or after their turn in the cage, or anywhere you need 3-4 hitting stations. Constructed from 4” square, heavy-duty steel poles, this black powder coated pole system is an attractive addition to any facility. Impact netting is constructed of black 3.5mm knotless 1-3/4” square mesh high-tenacity polypropylene (Pylon). Netting is hung from 1/4” galvanized steel cable and the system includes everything needed to install, including ground sleeves. Custom lengths are available.

- #66270 70' / 75' Model—4 hitting stations (3 poles) (specify 70' or 75' when ordering)
- #66255 55' Model—3 Hitting Stations (2 poles)

**\$2,155**  
**\$1,385**

### Protective Net Saver or Divider

Our #48 knotted braided polyethylene netting backdrop provides a buffer for your net as a Net Saver behind the batter or as a Net Divider position to create two short toss stations. The durable rope border simplifies installation and reduces sag. Available in black only.

- #36062 12' H x 12' W
- #36060 12' H x 14' W

**\$100**  
**\$115**

**THUD PADS** are 18 oz. vinyl over 4” thick polyurethane foam. **PROTECTOR PADS** are 18 oz. vinyl covered 1-1/2” polyethylene foam. Both have grommets for attachment. Available plain or with optional solid or framed targets and optional lettering. Custom sizes and thickness available.



Thud Pad 68"W x 52"H x 4" Thick
#1217612DS - \$325
Batting Tunnel Net Protector Pads: 3'W x 4'H x 1-1/2" Thick—BLACK
#200180453 - \$145



**YOUR “ONE-STOP” SOURCE FOR AMERICA’S BASEBALL, SOFTBALL & SPORTS SURFACES & SUPPLIES!**

PRICES SUBJECT TO CHANGE & AVAILABILITY PLUS SHIPPING | VOLUME DISCOUNTS AVAILABLE | COOPERATIVE PURCHASING CONTRACT PRICING FOR 50 STATES

# BEAM CLAY®

WHOLESALE PRICE LIST  
EFFECTIVE: JULY 1, 2021

Cage Saver Target | Batting Cage Backdrop Protector

## Vinyl Batting Tunnel / Batting Cage Hitting Backdrops

Heavy-duty 7' H x 5' W reinforced vinyl to protect the netting in your batting cage or tunnel with graphic TuffPrint™ strike zone. Brass grommets and 4 poly ropes included in corners for easy attachment.

18 oz. - Dark Green, Royal Blue or Black Vinyl, plain without Strike Zone or ropes.

**VBT-18OZ**      \$35

22 oz. - Dark Green, Royal Blue or Red Vinyl, with White Strike Zone.

**VBT-22OZ**      \$115

30 oz. - Navy Blue Vinyl with Yellow Strike Zone or Black Vinyl with Orange Strike Zone.

**VBT-30OZ**      \$125

Custom sizes & rope reinforced hems available



### CAGE SAVER TARGET

Help protect your batting cage net while giving your pitcher a visual backdrop to pitch to. Heavy duty tarp is made of 6'H x 5'W **40 OZ. reinforced vinyl**. Brass grommets along edges ensure a tight fit. Black vinyl with white strike zone. Includes two straps with clips to hang. **#CST65**

\$105/EA

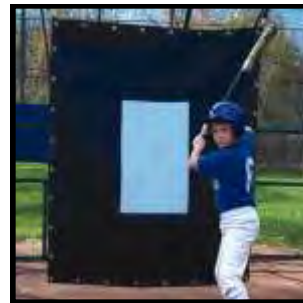

## VINYL BATTING TUNNEL / BATTING CAGE TARGET BACKDROP PROTECTORS

AER-FLO® CHROMA-BOND® DIGITAL IMPRINTING	
7'H X 5'W 22 OZ. CAGE SAVER DRK GRN #CS22-DGW, ROYAL #CS22-RBW, RED WITH WHITE #CS22-RW TARGET	\$135/EA
7'H X 5'W 22 OZ. CAGE SAVER DK GRN, ROYAL, RED NO TARGET #CS22-NOTARGET	\$105/EA
7'H X 5'W 30 OZ. CAGE SAVER BLACK W/ ORANGE TARGET #CS30-BO	\$155/EA
7'H X 5'W 30 OZ. CAGE SAVER NAVY #CS30-NY OR ROYAL #CS30-RY WITH YELLOW TARGET	\$155/EA

Heavy duty reinforced vinyl coated polyester tarp to protect netting in batting tunnel/cage  
Grommets are securely installed on corners.

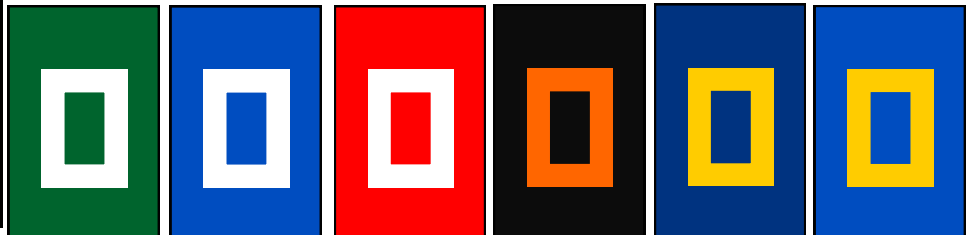

**YOUR "ONE-STOP" SOURCE FOR AMERICA'S BASEBALL, SOFTBALL & SPORTS SURFACES & SUPPLIES!**

PRICES SUBJECT TO CHANGE & AVAILABILITY PLUS SHIPPING | VOLUME DISCOUNTS AVAILABLE | COOPERATIVE PURCHASING CONTRACT PRICING FOR 50 STATES

# BEAM CLAY®

## WHOLESALE PRICE LIST EFFECTIVE: JULY 1, 2021

Batting Practice - Batting Tunnel Frames & Nets



<b>Installation Accessories</b>		
#34728	1/4" Cable, Galvanized, 500' Coil, 15 lbs./ft.	464
#15102	1/8" Cable, Galvanized, .10 lbs.	314
#34725	1/4" Cable Clamp, .25 lbs.	624
#34726	1/8" Cable Clamp, .25 lbs.	474
#34724	12" Turnbuckle (TB-12), 3 lbs.	\$35
#36986	6" Turnbuckle (TB-6), 1 lb.	\$25
#32670	C-Snap, Black Plated Steel, 4#/100	744
#32675	C-Snap, Black Plastic, 2#/100	404
#36000	8 mm Spring Link (Carabiner), 4#/100	894
#32679	5 mm Spring Link (Carabiner), 4#/100	494
#31663	3" S-Hook, Steel, 5#/100	454
#31601M	3/16" Polypro Braided Rope (1000'Roll), 14 lbs.	\$45.95
#41208	7.5" Steel Ground Pin, 7#/100	554
#34730	6" Eye Bolt, 1 lb.	\$9.25

**YOUR "ONE-STOP" SOURCE FOR AMERICA'S BASEBALL, SOFTBALL & SPORTS SURFACES & SUPPLIES!**

PRICES SUBJECT TO CHANGE & AVAILABILITY PLUS SHIPPING | VOLUME DISCOUNTS AVAILABLE | COOPERATIVE PURCHASING CONTRACT PRICING FOR 50 STATES

# BEAM CLAY®

## WHOLESALE PRICE LIST EFFECTIVE: JULY 1, 2021

### Aluminum Frame Batting Tunnels

## ALUMINUM FRAME BATTING TUNNELS



Engineered to withstand the rigors of both practice and the elements  
 No tedious tie-down cables extending beyond the posts with these high quality batting cages  
 Offset main uprights are fabricated of 4" diameter aluminum tubing, which install into aluminum ground sleeves  
 Mill finish aluminum. Powder-coated frames also available.  
 42# Nylon Netting 1-3/4" Square  
 Swivel pulleys with eyebolts are mounted at top to raise and lower the protective netting  
 Available in two standard sizes

**BT141455** 14'H x 14'W x 55'L  
**BT121470** 12'H x 14'W x 70'L

**\$6,565**  
**\$6,915**

Poles are 20'L (17.5' above ground & 2.5" in Ground)  
 2 adults required on site to manually unload.

## DUAL AND TRIPLE BATTING TUNNELS

Increase your batting practice area two-fold, or even three-fold, within a smaller footprint of your valuable field space with side-by-side dual batting tunnels or triple batting tunnels.

**BT141455-DUAL** 14'H x 14'W x 55'L  
**BT121470-DUAL** 12'H x 14'W x 70'L

**\$15,630**  
**\$17,180**



shown in black

## BATTING TUNNEL EZ ZIPPER ENTRANCE

Add an entrance to any batting tunnel or batting cage in three easy steps with this "EZ" Zipper.  
 Step #1: Zip tie the EZ Zipper wherever you want your entrance located. Step #2: Unzip the zipper.  
 Step #3: Use hot knife to simultaneously cut net between the zipper and prevent fraying.

**BTEZ** 14'H x 14'W x 55'L **\$150**



## PORTABLE BATTING TUNNEL

Engineered to withstand the rigors of both practice and the elements and, most importantly, it is portable. Eliminates the need to find one spot for batting practice and adds flexibility to locate anywhere, indoors and/or outdoors.

Artificial and natural grass friendly design, all components are rounded  
 Offset main uprights are fabricated of 4" diameter aluminum tubing (same as our in-ground model), which inserts into welded aluminum bases with receptacles to accept frame supports  
 2" sq. aluminum supports (top and bottom) are bolted to receptacles to rigorize the entire structure as one unit  
 Swivel pulleys with eyebolts are mounted at top to raise and lower the protective netting as needed  
 All hardware is rust-proof galvanized steel and stainless steel

**BT141455-P** 14'H x 14'W x 55'L  
**BT121470-P** 12'H x 14'W x 70'L

**\$16,930**  
**\$17,705**



**YOUR "ONE-STOP" SOURCE FOR AMERICA'S BASEBALL, SOFTBALL & SPORTS SURFACES & SUPPLIES!**

PRICES SUBJECT TO CHANGE & AVAILABILITY PLUS SHIPPING | VOLUME DISCOUNTS AVAILABLE | COOPERATIVE PURCHASING CONTRACT PRICING FOR 50 STATES



# BEAM CLAY®

**WHOLESALE PRICE LIST**  
 EFFECTIVE: JULY 1, 2021

Batting Practice - Batting Tunnels



### Professional Outdoor Batting Tunnel Frames

Clean frame design with less structure for balls to ricochet off. Individual hoist lines make for easy installation/removal of net!

- 4" aluminum tubing design
- Curved supports provide 3' offset
- Ground sleeves included
- Tunnel nets sold separately
- Design compatible with both 12' and 14' wide tunnel nets.
- 3 Year Limited Warranty
- Ships via common carrier
- Made in the USA

<b>PROTF-70</b>	70'L x 12'H, 400 lbs	<b>\$4,520/EA</b>
<b>PROTF-55</b>	55'L x 12'H, 350 lbs	<b>\$4,140/EA</b>

### Professional *Tandem* Outdoor Batting Tunnel Frames

Side by side clean frame design with less structure for balls to ricochet off. Individual hoist lines make for easy installation/removal of net!

- 4" aluminum tubing design
- Curved supports provide 3' offset
- Ground sleeves included
- Tunnel nets sold separately
- Design compatible with both 12' and 14' wide tunnel nets.
- Center supports spaced 5' apart for added safety.
- 3 Year Limited Warranty
- Ships via common carrier
- Made in the USA

<b>PROTF-70T</b>	70'L x 12'H, 800 lbs	<b>\$6,401/EA</b>
<b>PROTF-55T</b>	55'L x 12'H, 750 lbs	<b>\$5,364/EA</b>



**YOUR "ONE-STOP" SOURCE FOR AMERICA'S BASEBALL, SOFTBALL & SPORTS SURFACES & SUPPLIES!**

PRICES SUBJECT TO CHANGE & AVAILABILITY PLUS SHIPPING | VOLUME DISCOUNTS AVAILABLE | COOPERATIVE PURCHASING CONTRACT PRICING FOR 50 STATES

**PARTAC PEAT CORPORATION**  
 ONE KELSEY PARK, GREAT MEADOWS, NEW JERSEY 07838

800-247-BEAM (2326) • (908) 637-4191 • FAX (908) 637-8421  
 www.beamclay.com • sales@beamclay.com  
 Bid Term - 5/9/18 - 5/8/20; Extended to 5/8/21; Extended to 5/8/22

# BEAM CLAY®

## WHOLESALE PRICE LIST EFFECTIVE: JULY 1, 2021

### Batting Practice - Batting Tunnels

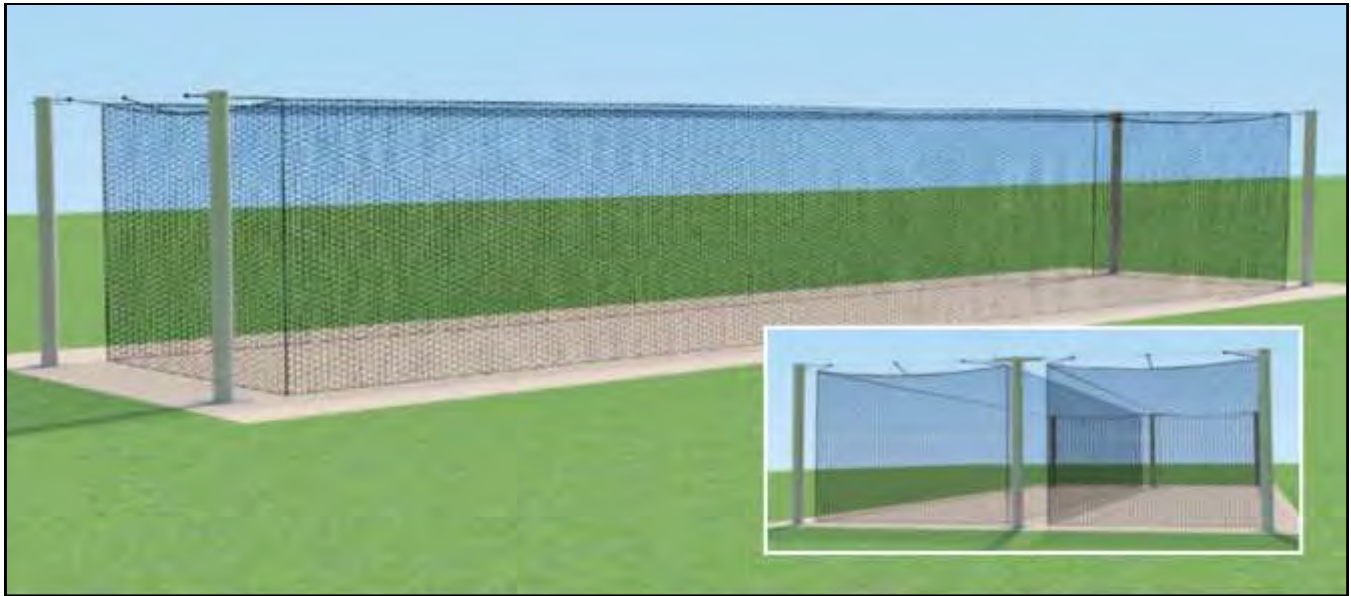

#### MEGA Outdoor Batting Tunnel

Clean frame design with less structure for balls to ricochet off. Easily slide net to one end for storage or remove snap hooks to pack net away during the off-season!

- 8" steel pole design with black powder coat finish
- Net attaches to tensioned galvanized aircraft cable
- Single tunnel and tandem tunnel models (permanent installation)
- #36 black knotted nylon net with 1 3/4" sq. mesh included
- 3 Year Limited Warranty
- Ships via common carrier
- Made in the USA

<b>MPCTF-55S</b>	Single 55', 1,100 lbs	<b>\$5,644/EA</b>
<b>MPCTF-55D</b>	Double 55', 1,700 lbs	<b>\$9,535/EA</b>
<b>MPCTF-70S</b>	Single 70', 1,150 lbs	<b>\$5,905/EA</b>
<b>MPCTF-70D</b>	Double 70', 1,800 lbs	<b>\$9,893/EA</b>



#### Semi-Permanent Outdoor Batting Tunnel Frames

- 2" galvanized steel tubing design
- Net hangs on 3 rows of galvanized aircraft cable
- Ground sleeves included
- Tunnel nets sold separately
- Design compatible with both 12' and 14' wide tunnel nets.
- 3 Year Limited Warranty
- Ships via common carrier
- Made in the USA

<b>BBTF-70</b>	5 Wickets - 70'L x 12'H, 418 lbs	<b>\$2,312/EA</b>
<b>BBTF-55</b>	4 Wickets - 55'L x 12'H, 400 lbs	<b>\$1,879/EA</b>

#### Surface-Mounted Outdoor Batting Tunnel Frames

- 2" galvanized steel tubing design
- Net hangs on 3 rows of galvanized aircraft cable
- 6" sq. surface-mount plates included
- Tunnel nets sold separately
- Design compatible with both 12' and 14' wide tunnel nets.
- 3 Year Limited Warranty
- Ships via common carrier
- Made in the USA

<b>BBTFSM-70</b>	5 Wickets - 70'L x 12'H, 250 lbs	<b>\$2,023/EA</b>
<b>BBTFSM-55</b>	4 Wickets - 55'L x 12'H, 225 lbs	<b>\$1,433/EA</b>

**YOUR "ONE-STOP" SOURCE FOR AMERICA'S BASEBALL, SOFTBALL & SPORTS SURFACES & SUPPLIES!**

PRICES SUBJECT TO CHANGE & AVAILABILITY PLUS SHIPPING | VOLUME DISCOUNTS AVAILABLE | COOPERATIVE PURCHASING CONTRACT PRICING FOR 50 STATES

# BEAM CLAY®

Batting Practice - Batting Tunnel Nets

WHOLESALE PRICE LIST  
EFFECTIVE: JULY 1, 2021

## Batting Tunnel Nets

Durable black nylon and polyethylene tunnel nets are weather-resistant and UV protected.



### All-Star Series Tunnel Nylon Nets

- #36 thread count
- Twisted knotted nylon net with 1 3/4" sq. mesh
- 3/8" twisted poly rope borders
- 1 Year Limited Warranty
- Ships via common carrier
- Made in the USA

Item	Description	Weight	Price
<b>BBC36-7014</b>	70'L x 14'W x 12'H	134 lbs	\$1,127
<b>BBC36-7012</b>	70'L x 12'W x 12'H	123 lbs	\$1,221
<b>BBC36-5514</b>	55'L x 14'W x 12'H	107 lbs	\$1,410
<b>BBC36-5512</b>	55'L x 12'W x 12'H	100 lbs	\$1,503

### Pro Climatized Tunnel Nets

- #42 thread count and high abrasion-resistant
- 2.5mm twisted knot polyethylene fiber net with 1 3/4" sq. mesh
- Roped perimeters and corners
- Recommended for outdoor use.
- 1 Year Limited Warranty
- Ships via common carrier
- Made in the USA

Item	Description	Weight	Price
<b>BBCP-7014</b>	70'L x 14'W x 12'H	132 lbs	\$1,202
<b>BBCP-7012</b>	70'L x 12'W x 12'H	126 lbs	\$1,088
<b>BBCP-5514</b>	55'L x 14'W x 12'H	111 lbs	\$970
<b>BBCP-5512</b>	55'L x 12'W x 12'H	100 lbs	\$886

### Collegiate Climatized Tunnel Nets

- #24 thread count
- 2mm polyethylene fiber with 1 3/4" sq. mesh
- Roped perimeters and corners
- Recommended for outdoor use.
- 1 Year Limited Warranty
- Ships via common carrier
- Made in the USA

Item	Description	Weight	Price
<b>BBCC-7014</b>	70'L x 14'W x 12'H	98 lbs	\$715
<b>BBCC-7012</b>	70'L x 12'W x 12'H	93 lbs	\$705



### Weighted Tunnel Sand TUBES

- Keep batting tunnel nets from blowing around. Add sand easily with zippered opening!
- 18 oz. black vinyl tube
- 5 net attachment clips included
- 60"L x 5"W
- 14 sand tubes recommended for a 70'L x 12'W batting tunnel, 10 for a 55' tunnel, one every 10' both lengths.
- 3 Year Limited Warranty, Made in the USA

**SWB-TUBE** (sand NOT included) 2 lbs **\$74/EA**

**YOUR "ONE-STOP" SOURCE FOR AMERICA'S BASEBALL, SOFTBALL & SPORTS SURFACES & SUPPLIES!**

PRICES SUBJECT TO CHANGE & AVAILABILITY PLUS SHIPPING | VOLUME DISCOUNTS AVAILABLE | COOPERATIVE PURCHASING CONTRACT PRICING FOR 50 STATES

# BEAM CLAY®

## WHOLESALE PRICE LIST EFFECTIVE: JULY 1, 2021

### Batting Practice - Batting Tunnel Frames & Nets



THREE FRAME UNIT SHOWN  
W/55' X 12' X 12' BATTING  
TUNNEL NET.

OTHER ITEMS SHOWN IN CAGE SOLD SEPA-  
RATELY

- PROTECTOR SCREEN
- VINYL SAVE
- TURF ROLL



**4-SUPPORT TUNNEL FRAME**  
(Recommended for 70' and larger Tunnels)

**3-SUPPORT TUNNEL FRAME**  
(Recommended for 55' Tunnels)

### Collegiate Tunnel Frames, 2" Square Galvanized

Composed of 2" square, 12 gauge galvanized steel tubing.  
Fits all cages up to 14' wide and 12' tall.  
System includes upright poles, cross member, ground sleeves, cable, clamps, eyebolts, turnbuckles and snap rings.  
Frame size after installation is 11' high x 16' wide.  
Net will hand 11' from the ground allowing 1' on the ground to contain balls. Actual frame ships truck, hardware pack ships UPS.  
1-Year Limited Warranty.  
Nets are sold separately.  
4-section frame recommended with nets 70' and longer.  
3-section frame recommended with nets 55' and shorter.

#BS10004	4-Support Tunnel Frame Kit	\$1,735
#BS10000	3-Support Tunnel Frame Kit	\$1,485
#BBFRMHDW	Hardware Repl. Only	\$345

### Collegiate Tunnel Nets

#### ALL-STAR SERIES TUNNELS

3.5mm, 1-3/4" black nylon netting  
36 thread twisted knotted  
380 lb. breaking test  
Nyothene weather treatment for outdoor use  
Durable vinyl border to prevent fraying  
Includes 14' x 12' backing to resist net wear behind batter  
Includes three full-length ropes to prevent sagging

#1245059DS	55'L x 14'W x 12'H	\$2,055
#1245042DS	70'L x 12'W x 12'H	\$2,170
#1245035DS	70'L x 14'W x 12'H	\$2,310



#### PRO SERIES TUNNELS

2.5mm, #42 thread count. "No-sag" net system.  
Twisted Knotted Polyethylene.  
100% water proof. UV treated. 1-3/4" square mesh.  
Extruded permanent Black color. Outdoor & indoor use.  
Ropes around perimeter and 4 corners.  
Three ropes running lengthwise on top.  
1-Year Limited Warranty.

#1149340	70'L x 14'W x 12'H	\$1,380
#1149357	70'L x 12'W x 12'H	\$1,205
#1242478	55'L x 14'W x 14'H	\$1,055
#1149371	55'L x 14'W x 12'H	\$1,000
#1149364	55'L x 12'W x 12'H	\$990



#### COLLEGIATE SERIES TUNNELS

2.0mm Twisted Knotted polyethylene.  
#24 thread count.  
1-Year Limited Warranty.  
Same great features as the 2.5mm above for young players or those on a tighter budget.

#1149388	70'L x 14'W x 12'H	\$990
#1149401	70'L x 12'W x 12'H	\$875
#1241044	55'L x 14'W x 14'H	\$935
#1149395	55'L x 14'W x 12'H	\$875
#1241037	35'L x 14'W x 12'H	\$630



**YOUR "ONE-STOP" SOURCE FOR AMERICA'S BASEBALL, SOFTBALL & SPORTS SURFACES & SUPPLIES!**

PRICES SUBJECT TO CHANGE & AVAILABILITY PLUS SHIPPING | VOLUME DISCOUNTS AVAILABLE | COOPERATIVE PURCHASING CONTRACT PRICING FOR 50 STATES

# BEAM CLAY®

**WHOLESALE PRICE LIST**  
EFFECTIVE: JULY 1, 2021

Batting Practice - Batting Tunnel Frames & Nets



## **PRO TUNNEL FRAMES**—SURFACE MOUNTED TO CONCRETE

Three Support Frames – accommodates up to 75' tunnel net  
Heavy-Duty 3.5" OD 13-gauge Galvanized steel pipe  
Surface-mount frames attach direct to concrete slab  
Includes Steel Cable, Clamps, Turn Buckles and Quick links  
Size after installation : 11.5'H x 16'W  
Complete installation instructions and hardware included  
Net sold separately  
5-Year Limited Warranty

- #1253634** 3 Section Frame—Surface Mount
- #1274639** 4 Section Frame—Surface Mount
- #1375091** 3 Section Frame—In-Ground
- #1375092** 4 Section Frame—In-Ground
- #1375093** Ground Sleeves (optional)

**\$3,055**  
**\$3,565**  
**\$2,555**  
**\$3,185**  
**\$130**

## **BATTING CAGE ZIP DOOR**

Add a door entry to any batting cage in minutes. Marine-grade vinyl that attaches using super stick Velcro and snaps. Simply cut an opening and attach. Size: 70"H x 24"W with a 64" zipper door opening. (Patent Pending)

**#BPZIPD**

**\$165**

## **BATTING CAGE DOOR**

- All steel frame - easy to assemble
- Free standing door
- Lacing rope included
- Door size: 30 1/2"W x 72 1/2"H
- Door frame: 33 3/4"W x 76 1/2"H
- Weight 35 lbs.

**#K50651**

**\$335**



**YOUR "ONE-STOP" SOURCE FOR AMERICA'S BASEBALL, SOFTBALL & SPORTS SURFACES & SUPPLIES!**

PRICES SUBJECT TO CHANGE & AVAILABILITY PLUS SHIPPING | VOLUME DISCOUNTS AVAILABLE | COOPERATIVE PURCHASING CONTRACT PRICING FOR 50 STATES

# BEAM CLAY®

WHOLESALE PRICE LIST  
 EFFECTIVE: JULY 1, 2021

Batting Practice—Batco Indoor/Outdoor Batting Tunnels

## BATCO™ INDOOR/OUTDOOR FOLD-UP BATTING TUNNELS

USE INDOORS OR OUTDOORS!

#36214	72' L x 18' W x 12' H (Baseball), 600 lbs.	\$6,015
#36216	54' L x 18' W x 12' H (Softball & Little League), 500 lbs.	\$5,235

### Cage Features

- Folds like an accordion for quick storage
- 72' cage folds to 2 feet in less than 2 minutes
- 50% wider and 20% higher than standard cage
- Arc shaped design for maximum hitting space
- Size allows live batting practice to be thrown comfortably
- Heavy-Duty #42 nylon net - 350 lb. tensile strength
- Zippered opening for easy cage entrance
- No permanent construction required
- No cables to run indoors
- No frame to build outdoors
- The customer will need to provide two end anchors (usually eye-bolts), one at each end of the cage
- Price includes 2 sets of feet—indoors & outdoors

The Batco cage can easily be folded and unfolded, like an accordion. After use, the Batco cage can be folded to 18' wide, 12' high, and just 2' long in less than 5 minutes. To collapse the cage you need two players per arc (8 players for the 54 footer and 10 for the 72') to slide the cage into storage. The players simply walk in unison, folding the cage up against the wall or fence as they walk.

\*Batco cages are very large. Be sure you have enough room in your gym. **No returns allowed.\***



PRICES SUBJECT TO CHANGE & AVAILABILITY PLUS SHIPPING | VOLUME DISCOUNTS AVAILABLE | COOPERATIVE PURCHASING CONTRACT PRICING FOR 50 STATES

## VARSITY BATTING CAGE FRAMES

Every piece of pipe in a Varsity Batting Cage Frame is made of industrial-gauge galvanized steel, to give you years of trouble-free use.

- Frame sets are available for all standard-size Varsity Nets. Special-order custom-size frames are also available.
- Each frame set comes complete with uprights, crossbars, cable hooks and ground sleeves.
- Complete instructions are included so you can set up your frame quickly and easily.
- **5-Year Guarantee on Batting Cage Frames**

FRAME FOR:		GAUGE:	ITEM #:	PRICE:	Required Assembly Space:
CAGE 1:	70' L x 14'W x 12'H	#27, #42 #60, #96	FR100	\$1,265	74'L x 18'W x 12'H
			FR105	\$2,010	74'L x 18'W x 12'H
CAGE 2:	55' L x 14'W x 12'H	#27, #42 #60, #96	FR200	\$1,265	59'L x 18'W x 12'H
			FR205	\$1,645	59'L x 18'W x 12'H
CAGE 3:	55' L x 14'W x 16'H	#42 #60, #96	FR300	\$1,560	59'L x 18'W x 16'H
			FR305	\$2,065	59'L x 18'W x 16'H
CAGE 4:	35' L x 14'W x 14'H	#42, #60, #96	FR405	\$1,250	39'L x 18'W x 14'H
CAGE 5:	70' L x 14'W x 16'H	#42, #60, #96	FR505	\$2,450	74'L x 18'W x 16'H
CAGE 7:	65' L x 11'W x 11'H	#27, #42 #60, #96	FR700	\$1,240	69'L x 15'W x 11'H
			FR705	\$1,890	69'L x 15'W x 11'H
CAGE 8:	55' L x 11'W x 11'H	#42 #60, #96	FR800	\$1,240	59'L x 15'W x 11'H
			FR805	\$1,535	59'L x 15'W x 11'H
CAGE 9:	70' L x 12'W x 12'H	#42 #60, #96	FR190	\$1,240	74'L x 16'W x 12'H
			FR195	\$1,975	74'L x 16'W x 12'H
CAGE 10:	55' L x 12'W x 12'H	#27, #42 #60	FR290	\$1,265	59'L x 16'W x 12'H
			FR295	\$1,595	59'L x 16'W x 12'H
SPLIT CAGE™	70' L x 14'W x 12'H	#96	FR105	\$2,010	74'L x 18'W x 12'H



### Net Installation Kits

#N8000	Indoor Installation Kit	\$105
#N8010	Optional Outdoor Installation Kit: The Optional Outdoor Installation Kit gives you the option of sliding your batting cage net to the end of your frame after use. For #42 Nets #1, #2, #3, #7, #8, #9 and #10 and #27 Nets #1, #2, #7 and #10.	\$105



### Ceiling Installation Kit #N8005:

This kit includes everything you need to hang your Varsity Net so it will slide, upper wall to upper wall, on cables. It enables you to slide your net and cables easily and safely out of the way after practice. Ceiling Installation Kits include the following: (3) 100' horizontal heavy-duty aircraft cable lengths, (35) metal snap rings, (6) turnbuckles, (30) 30' vertical cable lengths, (35) plastic snap hooks, (6) steel pulleys, (66) cable clamps and (6) eye bolts.

#N8005	\$365
--------	-------

**YOUR "ONE-STOP" SOURCE FOR AMERICA'S BASEBALL, SOFTBALL & SPORTS SURFACES & SUPPLIES!**

PRICES SUBJECT TO CHANGE & AVAILABILITY PLUS SHIPPING | VOLUME DISCOUNTS AVAILABLE | COOPERATIVE PURCHASING CONTRACT PRICING FOR 50 STATES

# BEAM CLAY®

## WHOLESALE PRICE LIST EFFECTIVE: JULY 1, 2021

### Varsity Batting Cage Nets

10 standard sizes of varsity batting cage nets in stock at all times.

CAGE 1:	70' L x 14' W x 12' H	
#27 Polyethylene	N1110	\$645
#42 Polyethylene	N1000	\$975
#60 Polyethylene	N1005	\$1,205
#96 POLYESTER	N1007	\$2,085
CAGE 2:	55' L x 14' W x 12' H	
#27 Polyethylene	N2110	\$545
#42 Polyethylene	N2000	\$800
#60 Polyethylene	N2005	\$1,120
#96 POLYESTER	N2007	\$1,735
CAGE 3:	55' L x 14' W x 16' H	
#42 Polyethylene	N3000	\$900
#60 Polyethylene	N3005	\$1,340
#96 POLYESTER	N3007	\$2,010
CAGE 4:	35' L x 14' W x 14' H	
#42 Polyethylene	N4000	\$645
#60 Polyethylene	N4005	\$875
#96 POLYESTER	N4007	\$1,395
CAGE 5:	70' L x 14' W x 16' H	
#42 Polyethylene	N5000	\$1,120
#60 Polyethylene	N5005	\$1,615
#96 POLYESTER	N5007	\$2,395
CAGE 7:	65' L x 11' W x 11' H	
#27 Polyethylene	N7310	\$545
#42 Polyethylene	N7200	\$800
#60 Polyethylene	N7205	\$1,120
#96 POLYESTER	N7207	\$1,755
CAGE 8:	55' L x 11' W x 11' H	
#42 Polyethylene	N8100	\$690
#60 Polyethylene	N8105	\$975
#96 POLYESTER	N8107	\$1,525
CAGE 9:	70' L x 12' W x 12' H	
#42 Polyethylene	N1900	\$910
#60 Polyethylene	N1905	\$1,285
#96 POLYESTER	N1907	\$1,920
CAGE 10:	55' L x 12' W x 12' H	
#27 Polyethylene	N2910	\$490
#42 Polyethylene	N2900	\$765
#60 Polyethylene	N2905	\$1,120
#96 POLYESTER	N2907	\$1,615
Split Cage™	70' L x 14' W x 12' H	
#96 POLYESTER	N1010	\$3,210

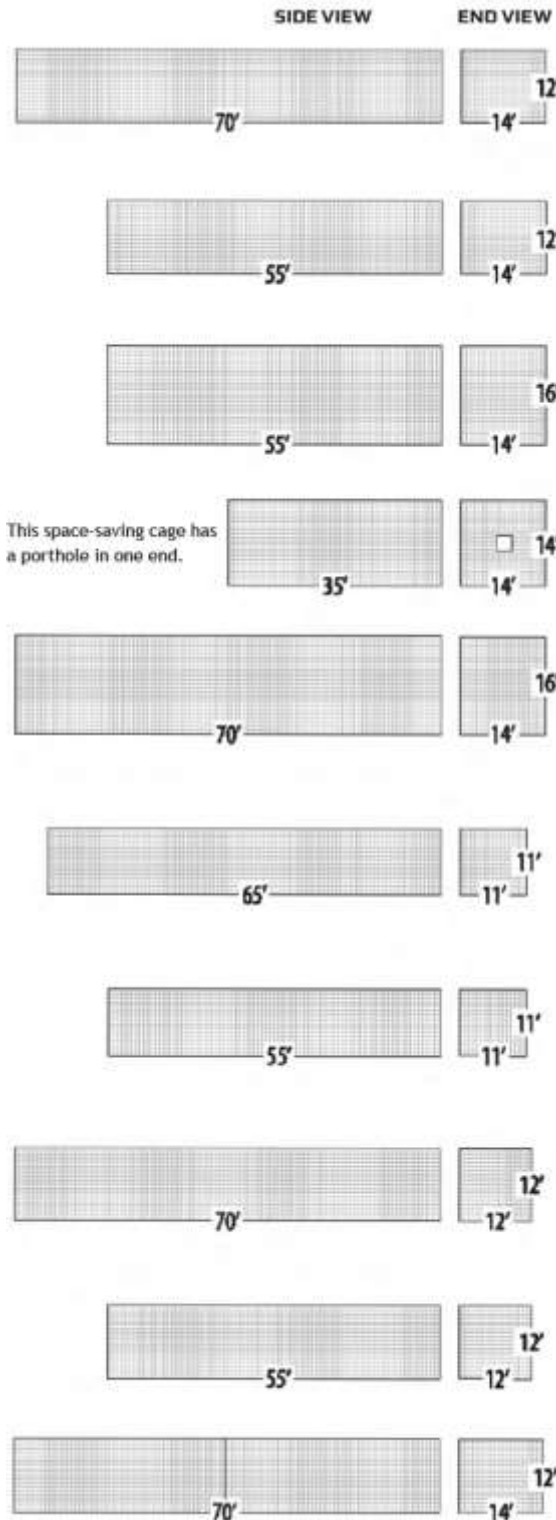

We pride ourselves in giving you the best selection and the highest quality batting cages at the lowest prices possible.



**YOUR "ONE-STOP" SOURCE FOR AMERICA'S BASEBALL, SOFTBALL & SPORTS SURFACES & SUPPLIES!**

PRICES SUBJECT TO CHANGE & AVAILABILITY PLUS SHIPPING | VOLUME DISCOUNTS AVAILABLE | COOPERATIVE PURCHASING CONTRACT PRICING FOR 50 STATES



# BEAM CLAY®

## WHOLESALE PRICE LIST

### Varsity Batting Cage Nets

#### Twisted Knotted Black Polyethylene #27, #42 and #60 Batting Cage Netting features and benefits:

- Polyethylene available in 3 strengths: #27, #42 and #60.
- Twisted Knotted Black Polyethylene Nets are hung on the square and are designed specifically for baseball and softball use.
- All varsity nets come with a Hitter's Door for easy in-and-out access.
- Knotted nets have a higher overall strength and durability rating making them superior for direct impact sports like baseball and softball.
- Twisted netting has a higher abrasion resistance than braided, because twisted has less surface area than braided. This allows the balls to slide and spin off of the surface.
- Polyethylene netting doesn't absorb water—perfect for wet or humid hot climates—This is the best protection to prevent rotting.
- All varsity nets are black and offer the best protection from the affects of sunlight—the darker the color, the greater the UV deflection.
- We incorporate the industries highest UV protection.
- Varsity netting is hydraulically depth stretched to improve knot tightness and reduce stretching and shrinking over time.
- Baseball and Softball size mesh—13/4".
- Heavy-Duty Polypropylene Black Rope Borders on top, bottom, and vertical corners. Rib-Line Ropes down the center for extra suspension points with less sagging.
- 1-Year Guarantee on #42 and #60.



#### Quality Features on all Varsity Netting:

##### Twisted Strands

Our twisted netting has a higher abrasion resistance than braided, because twisted has less surface area than braided. This allows the balls to slide and spin off of the surface.



##### Extruded Black Core

Other nets have a white core with black surface coat.

##### Special UV Formula

Our patented UV inhibitors prevent nets from becoming brittle.



**Varsity Twisted Knotted Batting Cages have a high overall strength and durability rating making them superior for direct impact sports like baseball and softball.**

#### Commercial-Grade Twisted Knotted Black POLYESTER #96 Batting Cage Netting features and benefits:

##### OUR TOP OF THE LINE NETTING

- POLYESTER** available in one strength: #96
- Same great features and benefits as Polyethylene.
- Strongest: The highest breaking strength and most abrasion resistant netting you can buy.
- Won't mildew.
- Higher UV resistance.
- 2-Year Guarantee



**YOUR "ONE-STOP" SOURCE FOR AMERICA'S BASEBALL, SOFTBALL & SPORTS SURFACES & SUPPLIES!**

PRICES SUBJECT TO CHANGE & AVAILABILITY PLUS SHIPPING | VOLUME DISCOUNTS AVAILABLE | COOPERATIVE PURCHASING CONTRACT PRICING FOR 50 STATES

# BEAM CLAY®

Hit at Home Backyard Batting Cage

WHOLESALE PRICE LIST  
EFFECTIVE: JULY 1, 2021



## Hit at Home® Backyard Batting Cage #A5030

### Features, Benefits & Facts:

Compact yet spacious size allows batting practice to be thrown comfortably. Also, great for short toss, soft toss, or tee drills.

#27 Twisted Knotted Black Polyethylene Netting. Perfect for Backyard use.

Powder coated grey steel tubing holds up very well to strong sun or rain, looks great for years.

Vision enhanced coated guy-wires and doubled staked at corners for added safety and durability

Quickly dismantles—simply unhook turnbuckles to lower entire cage to the ground.

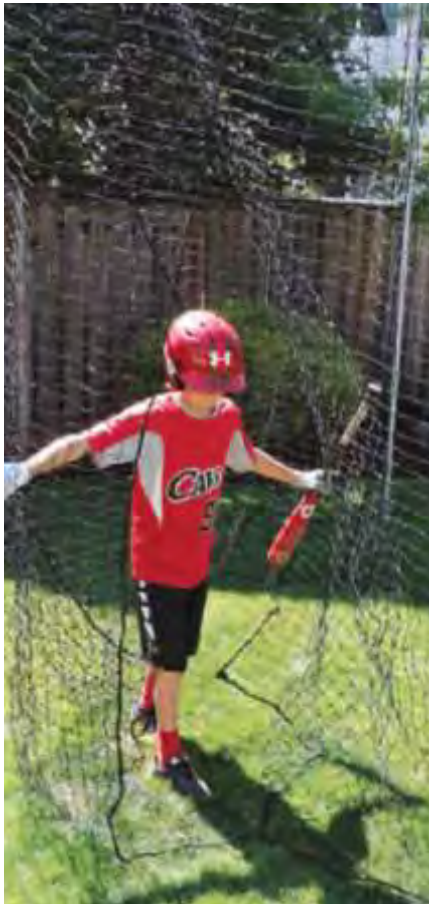

Hit at Home® Backyard Batting Cage comes with Hitter's Door for easy in-and-out access.

No permanent construction required.  
Two person setup in less than 1 hour.

**A5030**    **\$875**

The Hit at Home® Backyard Batting Cage features #27 Twisted Knotted Black Polyethylene Netting, is hung on the square and is designed specifically for baseball and softball use.

Knotted nets have a higher overall strength and durability rating making them superior for direct impact sports like baseball and softball. Twisted netting has a higher abrasion resistance than braided, because twisted has less surface area than braided. This allows the balls to slide and spin off of the surface. Polyethylene netting doesn't absorb water—perfect for wet or humid hot climates—This is the best protection to prevent rotting.

Perfect for backyards, or small hitting areas.

**45'L x 11'W x 11'H**



The Hit at Home® Backyard Batting Cage comes with everything you'll need to set up your cage

Including: (6) 1.5 inch powder coated uprights, (3) crossbars cables, (12) vision-enhanced coated guy-wires, (6) cable hangers, (16) steel ground stakes, (3) turnbuckles, (36) snap rings and (12) eyebolts.



**YOUR "ONE-STOP" SOURCE FOR AMERICA'S BASEBALL, SOFTBALL & SPORTS SURFACES & SUPPLIES!**

PRICES SUBJECT TO CHANGE & AVAILABILITY PLUS SHIPPING | VOLUME DISCOUNTS AVAILABLE | COOPERATIVE PURCHASING CONTRACT PRICING FOR 50 STATES

# BEAM CLAY®

**WHOLESALE PRICE LIST**  
 EFFECTIVE: JULY 1, 2021

## Batting Cages



### Multi-Sport Instant Cage®

Perfect for short-toss and soft-toss drills.  
 Quick-Snap® connections make for fast and easy assembly.  
 Makes a terrific portable backstop for batting practice and can easily be moved from place to place on your practice field.  
 5-year guarantee on frame. 1-year guarantee on netting.

**A5010**     **\$765**

This giant 12' x 12' x 9' Multi-Sport Instant Cage® is ideal for your backyard or practice field. It can be used for baseball, softball, golf, football, soccer, tennis or discus.



### Portable Free-Standing Sports Cage™

It can be used to practice a multitude of sports at the same time, including baseball, softball and golf, and can be set up in less than an hour.  
 This cage is unique in that it comes with both 191-lb. Knotted Nylon and Golf-Mesh Nylon Netting.  
 This Large Sports Cage will fit comfortably in your backyard or on any practice field.  
 5-year guarantee on frame.  
 1-year guarantee on netting.

**A5005**     **\$1,755**

This 50' x 11' x 11' full-length sports cage requires no tools to assemble with patented QUICK-SNAP® connections, is fully enclosed, free-standing and portable.

**YOUR “ONE-STOP” SOURCE FOR AMERICA’S BASEBALL, SOFTBALL & SPORTS SURFACES & SUPPLIES!**

PRICES SUBJECT TO CHANGE & AVAILABILITY PLUS SHIPPING | VOLUME DISCOUNTS AVAILABLE | COOPERATIVE PURCHASING CONTRACT PRICING FOR 50 STATES

# BEAM CLAY®

## WHOLESALE PRICE LIST EFFECTIVE: JANUARY 1, 2021

### Designated Hitter

#### DESIGNATED HITTER—PRO

The Designated Hitter™ Pro will help your pitcher learn how to pitch inside and handle a hitter who might be crowding the plate.

The Designated Hitter™ Pro is the ideal pitcher's training tool for baseball and softball pitchers at the advanced level. It allows your pitchers to have a live training or a more realistic bullpen session without the need for a live batter. This dummy model gives your pitchers a more efficient, effective and safe training session while practicing on the mound. The Designated Hitter™ pitching dummy stands 5'9" tall, can be used in either indoor or outdoor facilities, and comes with a weighted base to allow it to stand on its own. It is made with durable materials so it will not break when hit by fastballs. The Designated Hitter™ Pro is also constructed with beveled edges to reduce pitch deflection and provide a safer experience for your catchers. An orange string that attaches to the elbow of the dummy provides a visual representation of the inside corner of the strike zone for your pitchers to aim at. The DH displays all of the hitter's key landmarks, giving pitchers a complete image of the strike zone. This helps pitchers develop more consistency in the accuracy and trajectory of their pitches. This helps your baseball and softball pitchers visualize the zone and practice hitting their marks.

- The Designated Hitter™ Pro Model
- Can be used indoors or outdoors
  - Simulates a left or right-handed batter
  - Is designed for baseball or softball teams
  - Is portable and easy to transport
  - Comes in red, blue or gray color

#TA2131R	Red 5'9" Tall Pro Model	\$345
#TA2131B	Blue 5'9" Tall Pro Model	\$345
#TA2131G	Grey 5'9" Tall Pro Model	\$345

#### DESIGNATED HITTER—YOUTH

The Designated Hitter™ Youth is the ideal pitcher's training tool for baseball and softball pitchers at the advanced level. It allows your pitchers to have a live training or bullpen session without the need for a live batter. This gives you a more efficient, effective and safe training session. The Designated Hitter™ pitching dummy stands 5'2" tall and comes with a weighted base to allow it to stand on its own. It is made with durable materials so it will not break when hit by fastballs. It is also constructed with beveled edges to reduce pitch deflection and provide a safer experience for your catchers. An orange string that attaches to the elbow of the dummy provides a visual representation of the inside corner of the strike zone for your pitchers to aim at. This helps your baseball and softball pitchers visualize the zone and practice hitting their marks.

- The Designated Hitter™ Youth Model
- Can be used indoors or outdoors
  - Simulates a left or right-handed batter
  - Is designed for baseball or softball teams
  - Is portable and easy to transport
  - Comes in red, blue or gray color

#TA2132R	Red 5'2" Tall Youth Model	\$345
#TA2132B	Blue 5'2" Tall Youth Model	\$345
#TA2132G	Grey 5'2" Tall Youth Model	\$345



**YOUR "ONE-STOP" SOURCE FOR AMERICA'S BASEBALL, SOFTBALL & SPORTS SURFACES & SUPPLIES!**

PRICES SUBJECT TO CHANGE & AVAILABILITY PLUS SHIPPING | VOLUME DISCOUNTS AVAILABLE | COOPERATIVE PURCHASING CONTRACT PRICING FOR 50 STATES

# BEAM CLAY®

## WHOLESALE PRICE LIST

Pitching Machines—JUGS



**YOUR “ONE-STOP” SOURCE FOR AMERICA’S BASEBALL, SOFTBALL & SPORTS SURFACES & SUPPLIES!**

PRICES SUBJECT TO CHANGE & AVAILABILITY PLUS SHIPPING | VOLUME DISCOUNTS AVAILABLE | COOPERATIVE PURCHASING CONTRACT PRICING FOR 50 STATES

**PARTAC PEAT CORPORATION**  
ONE KELSEY PARK, GREAT MEADOWS, NEW JERSEY 07838

800-247-BEAM (2326) • (908) 637-4191 • FAX (908) 637-8421  
www.beamclay.com • sales@beamclay.com  
Bid Term - 5/9/18 - 5/8/20; Extended to 5/8/21; Extended to 5/8/22

**BEAM CLAY®**

Pitching Machines—JUGS

**WHOLESALE PRICE LIST**  
 EFFECTIVE: JULY 1, 2021

# BP3

*Baseball Pitching Machine with Change-Up*

BP3 Baseball	<b>M1030</b>	<b>\$4,235</b>
New! BPS Softball	<b>M1035</b>	<b>\$4,235</b>

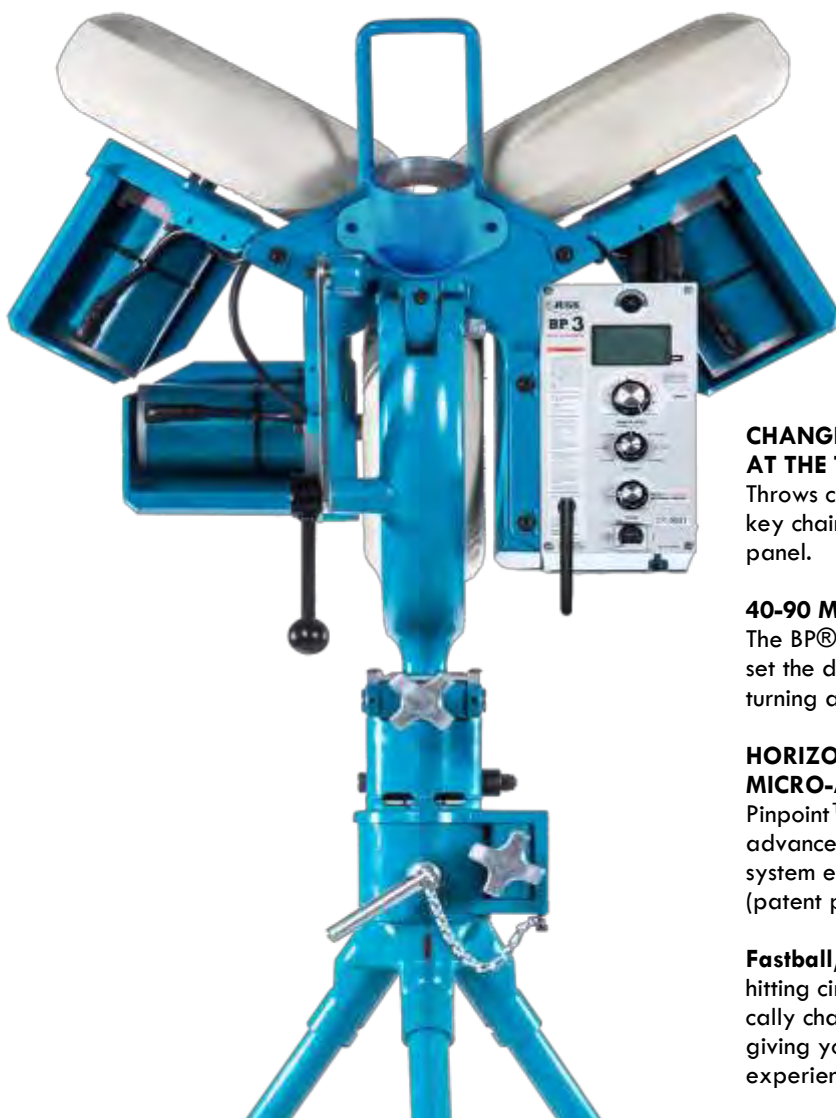

**CHANGE FROM FASTBALL TO CHANGEUP AT THE TOUCH OF A BUTTON**

Throws changeups using the remote control on key chain or manual button located on control panel.

**40-90 MPH SPEED RANGE**

The BP®3 has a large 3" LCD display. You to set the digital speed you desire by simply turning a knob.

**HORIZONTAL AND VERTICAL MICRO-ADJUSTMENT**

Pinpoint™ control at your fingertips—the most advanced and easy to use pitch targeting system ever developed for a pitching machine (patent pending.)

**Fastball/Changeup Hitting Circuit:** 3 preset hitting circuits allows the machine to automatically change between fastball and changeup giving your hitters a "real" pitcher vs. hitter experience.

**Throws these ball types:** Throws baseballs, the JUGS Pearl®, JUGS Sting-Free® baseballs—dimpled and seam, JUGS Lite-Flite® and SOFTIE® baseballs, and JUGS BULL-DOG™ baseballs.

**Select-A-Pitch™ Dial:**

**The BP®3 throws the following nine pitches:** Fastballs and changeups, right and left-handed curveballs and sliders, right and left-handed cutters and split-finger fastballs.

**YOUR "ONE-STOP" SOURCE FOR AMERICA'S BASEBALL, SOFTBALL & SPORTS SURFACES & SUPPLIES!**

PRICES SUBJECT TO CHANGE & AVAILABILITY PLUS SHIPPING | VOLUME DISCOUNTS AVAILABLE | COOPERATIVE PURCHASING CONTRACT PRICING FOR 50 STATES

# BEAM CLAY®

Pitching Machines—JUGS

WHOLESALE PRICE LIST

## BP3

Baseball Pitching Machine with Change-Up

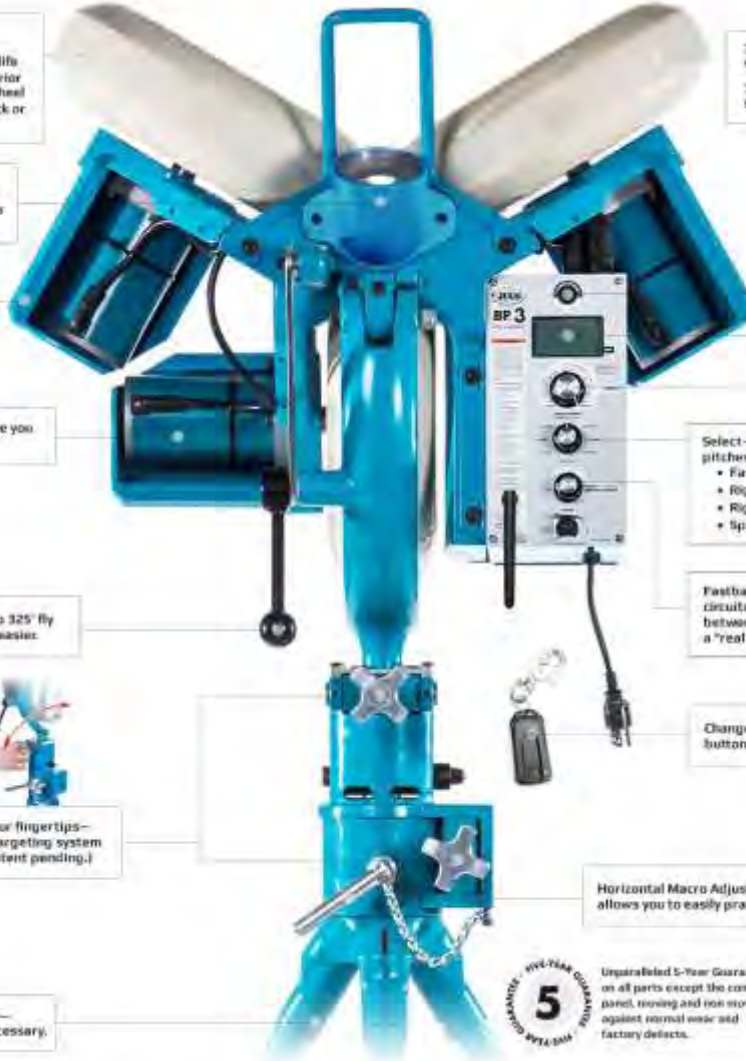

Patented Grip-Tite® 12" non-marking, pneumatic tires—Average 20-year life expectancy compared to 5-year solid-tire life expectancy. Grip-Tite® tires provide superior pitch accuracy compared to any other 3-wheel machine. Grip-Tite® tires will not melt, crack or chunk like solid tires.

Always see the ball™ delivery system: A clear and uninterrupted view of the ball throughout the entire pitch process allows the hitter to realistically time their stride.

Three cast-aluminum motor guards protect motors from direct hits.

Three 1/4 HP motors will give you years of trouble-free use.

Vertical Macro Adjustment: Throwing deep 325' fly balls or towering pop-ups has never been easier.



Micro-Adjustment: Pinpoint™ control at your fingertips—the most advanced and easy to use pitch targeting system ever developed for a pitching machine (patent pending.)

Click-Snap® leg attachment—No T-handle or leg clamp necessary.

3 wheel design eliminates the need to rotate the machine to change pitches.  
3 wheels provide better contact with the ball for exceptional pitch control and accuracy.

Throws Changeups: change from fastball to changeup at the touch of a button using the manual button located on control panel.

Large 3" LCD Readout Display

Digital Speed Adjustment: 40-90 mph.

Select-A-Pitch™ Dial: Throw the following nine pitches at the turn of a dial.  
• Fastballs and Changeups  
• Right- and Left-handed Curveballs and Sliders  
• Right- and Left-handed Cutters  
• Split-finger Fastballs

Fastball/Changeup Hitting Circuit: 3 preset hitting circuits allow the machine to automatically change between fastball and changeup giving your hitters a "real" pitcher vs. hitter experience.

Change from fastball to changeup at the touch of a button using the remote control on key chain.

Horizontal Macro Adjustment Lever: 360 degree rotation allows you to easily practice using the entire field.



Unparalleled 5-Year Guarantee on all parts except the control panel, moving and non-moving, against normal wear and factory defects.



2-Year Guarantee on control unit against normal wear and factory defects.



**YOUR "ONE-STOP" SOURCE FOR AMERICA'S BASEBALL, SOFTBALL & SPORTS SURFACES & SUPPLIES!**

PRICES SUBJECT TO CHANGE & AVAILABILITY PLUS SHIPPING | VOLUME DISCOUNTS AVAILABLE | COOPERATIVE PURCHASING CONTRACT PRICING FOR 50 STATES

**PARTAC PEAT CORPORATION**  
ONE KELSEY PARK, GREAT MEADOWS, NEW JERSEY 07838

800-247-BEAM (2326) • (908) 637-4191 • FAX (908) 637-8421  
www.beamclay.com • sales@beamclay.com  
Bid Term - 5/9/18 - 5/8/20; Extended to 5/8/21; Extended to 5/8/22

**BEAM CLAY®**

Pitching Machines—JUGS

**WHOLESALE PRICE LIST**  
 EFFECTIVE: JULY 1, 2021

# BP2

*Baseball Pitching Machine*

M1020

\$3,075



**Designed specifically to simplify your batting practice.**

**Features, Benefits & Facts:**

- 6 Preset Pitch Positions
- Digital Speed Adjustment
- Select-A-Pitch™ Dial
- Pinpoint™ Micro-Adjustment: the most advanced and easy to use pitch targeting system ever. Locate pitches instantly—right to left, up or down with a quick turn of your wrist (patent pending.)
- Patented Grip-Tite® 12" non-marking pneumatic tires Average 20 year life expectancy.
- Realistic 64" delivery height.
- Weight: 125 lbs.
- Throws baseballs, JUGS Pearl®, Sting-Free® baseballs, Lite-Flite® baseballs, Softie® baseballs and Bulldog™ polyballs.
- Quick-Snap® leg attachment. No T-handle or leg clamp. Easy to move and set up.
- Runs on 110-volt AC, Yamaha® EF2000iS v2 Inverter Generator or the Complete Practice Battery Pack.

Recommended Age	12-Adult
Speed Range	45-90 mph
Speed Adjustment	Digital Speed Readout
Pinpoint™ Micro Adjustment	Yes
Select-A-Pitch™	Yes
Realistic 64 " Delivery Height	Yes
Patented Grip-Tite® Tires	Yes
Weight	125 lbs.
360-Degree Swivel	No
Power Source	110V AC (see features)
Motors	(2) 1/4 HP, 3 amp
Optional Pitching Machine Cover	Yes
Optional Automatic Feeder	No

Unparalleled 5-Year Guarantee on all parts, moving and non-moving, against normal wear and factory defects.

**YOUR "ONE-STOP" SOURCE FOR AMERICA'S BASEBALL, SOFTBALL & SPORTS SURFACES & SUPPLIES!**

PRICES SUBJECT TO CHANGE & AVAILABILITY PLUS SHIPPING | VOLUME DISCOUNTS AVAILABLE | COOPERATIVE PURCHASING CONTRACT PRICING FOR 50 STATES

**PARTAC PEAT CORPORATION**  
 ONE KELSEY PARK, GREAT MEADOWS, NEW JERSEY 07838

800-247-BEAM (2326) • (908) 637-4191 • FAX (908) 637-8421  
 www.beamclay.com • sales@beamclay.com  
 Bid Term - 5/9/18 - 5/8/20; Extended to 5/8/21; Extended to 5/8/22



# BEAM CLAY®

Pitching Machines—JUGS

WHOLESALE PRICE LIST

## BP2

Baseball Pitching Machine



### Select-A-Pitch™

Changing pitches is as easy as turning a knob.

### Digital Speed Adjustment

Set the digital speed to the speed you desire. 45-90 mph range.

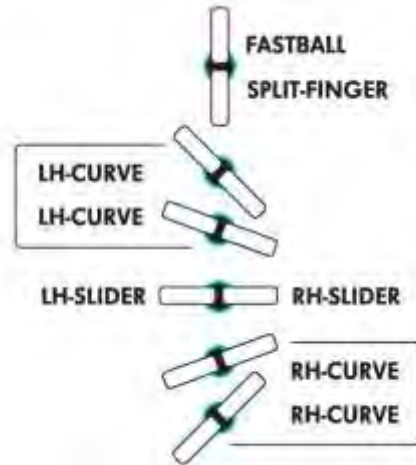

**6 Preset Pitch Positions**— Tire chassis rotates around the feed chute for fast and easy setup.



Fastball/Split Finger



Left-Handed Curveball



Right- and Left-Handed Slider



Right-Handed Curveball



**Realistic 64" delivery height.** Delivers pitches at a realistic downward plane.

**YOUR "ONE-STOP" SOURCE FOR AMERICA'S BASEBALL, SOFTBALL & SPORTS SURFACES & SUPPLIES!**

PRICES SUBJECT TO CHANGE & AVAILABILITY PLUS SHIPPING | VOLUME DISCOUNTS AVAILABLE | COOPERATIVE PURCHASING CONTRACT PRICING FOR 50 STATES

**PARTAC PEAT CORPORATION**  
ONE KELSEY PARK, GREAT MEADOWS, NEW JERSEY 07838

800-247-BEAM (2326) • (908) 637-4191 • FAX (908) 637-8421  
www.beamclay.com • sales@beamclay.com  
Bid Term - 5/9/18 - 5/8/20; Extended to 5/8/21; Extended to 5/8/22

**BEAM CLAY®**

Pitching Machines—JUGS

**WHOLESALE PRICE LIST**  
EFFECTIVE: JULY 1, 2021

# Changeup Super Softball™ Pitching Machine

**Risers and fastballs up to 70 mph and changeups at speeds as low as 44 mph.**

**Features, Benefits & Facts:**

**M1251** **\$2,305**  
With Transport cart **M1250** **\$2,415**

Remote control on key chain or manual button located on control panel—Change from fastball to changeup at the touch of a button.  
Digital Speed Display—70 mph top speed  
Weights just 75 lbs. One person can load the JUGS in the trunk of a car.  
Throws 11" or 12" softballs, Leather-Last™ softballs, Sting-Free® softballs, Lite-Flite® softballs, Softie® softballs and the Bulldog™ polyballs. Comes standard with a 12" ball chute. An 11" ball chute is sold separately.  
Great for offensive or defensive drills—Change speeds while practicing advanced outfield drills. Swivel-design base also provides 360-degree movement for fly balls, pop-ups and ground balls.  
Runs on 110-volt AC or the Yamaha® EF2000iS v2 Inverter Generator.  
**NEW** Optional 18-Ball Carousel Ball Feeder—Throws regulation size and weight softballs. See page 36.

**Recommended Skill Level**

High School  
College  
Advanced Travel-Ball

**Speed Range**

15-70 mph



Moving your machine is easy with the optional Transport Cart. Once your machine is attached to the Transport Cart's base, simply insert the handle, tilt and roll.



**NEW OPTION:**  
Now available with or with cart

Recommended Age	12-Adult
Speed Range	15-70 mph
Speed Adjustment	Digital Speed Readout
Changeup Remote Control	Yes
Manual Changeup Button	Yes
Pneumatic Tire	Yes
Weight	75 lbs.
360-Degree Swivel	Yes
Power Source	110V AC (see features)
Motors	(1) 1/4 HP, 3 amp
Optional Softball Transport Cart	Yes
Optional Pitching Machine Cover	Yes
<b>NEW</b> Optional Carousel Feeder	Yes

Unparalleled 5-Year Guarantee on all parts except the control panel, moving and non-moving, against normal wear and factory defects.

2-Year Guarantee on control panel and handheld remote control unit against normal wear and factory defects.

**YOUR "ONE-STOP" SOURCE FOR AMERICA'S BASEBALL, SOFTBALL & SPORTS SURFACES & SUPPLIES!**

PRICES SUBJECT TO CHANGE & AVAILABILITY PLUS SHIPPING | VOLUME DISCOUNTS AVAILABLE | COOPERATIVE PURCHASING CONTRACT PRICING FOR 50 STATES

# BEAM CLAY®

## WHOLESALE PRICE LIST

Pitching Machines—JUGS

# Changeup Super Softball™ Pitching Machine

**For the first time change speeds without the hitter knowing it!**

Switch between fastballs and changeups with the touch of a button using the hand-held remote control. Remote control can be used at the machine, behind the hitter or even in the dugout.



**JUGS NEW**  
Optional  
18-Ball Carousel Feeder  
See page 36.



The JUGS Changeup Super Softball™ Pitching Machine's changeup feature and higher speed range is designed for the advanced player whose skills demand practicing at game-like speeds.



**YOUR "ONE-STOP" SOURCE FOR AMERICA'S BASEBALL, SOFTBALL & SPORTS SURFACES & SUPPLIES!**

PRICES SUBJECT TO CHANGE & AVAILABILITY PLUS SHIPPING | VOLUME DISCOUNTS AVAILABLE | COOPERATIVE PURCHASING CONTRACT PRICING FOR 50 STATES

**BEAM CLAY®**

Pitching Machines—JUGS

**WHOLESALE PRICE LIST**  
EFFECTIVE: JULY 1, 2021

# Changeup Baseball Pitching Machine



**M1450**

**\$2,305**

**Up to 70 mph fastballs and changeups at speeds as low as 44 mph.**

**Features, Benefits & Facts:**

Remote control on key chain or manual button located on control panel—Change from fastball to changeup at the touch of a button.

Realistic 64" delivery height—ball travels to hitter on a downward plane.

Digital Speed Display—70 mph top speed. New lower changeup speed—as low as 44 mph.

Weighs just 80 lbs. One person can load the JUGS in the trunk of a car.

Throws baseballs, Pearl® leather baseballs, Sting-Free® baseballs, Lite-Flite® baseballs, Softie® baseballs and the Bulldog™ polyballs.

Great for offensive or defensive drills—Change speeds while practicing advanced outfield drills. Swivel-design base also provides 360-degree movement for fly balls, pop-ups and ground balls.

Runs on 110-volt AC or the Yamaha® EF2000iS v2 Inverter Generator.

**NEW** Optional 36-Ball Carousel Ball Feeder—throws regulation size and weight baseballs.—See page 36.

**Recommended Skill Level**

High School  
College  
Advanced Travel-Ball

**Speed Range**

15-70 mph

Recommended Age	12-Adult
Speed Range	15-70 mph
Speed Adjustment	Digital Speed Readout
Changeup Remote Control	Yes
Manual Changeup Button	Yes
Pneumatic Tire	Yes
Weight	75 lbs.
360-Degree Swivel	Yes
Power Source	110V AC (see features)
Motors	(1) 1/4 HP, 3 amp
Optional Softball Transport Cart	Yes
Optional Pitching Machine Cover	Yes
<b>NEW</b> Optional Carousel Feeder	Yes

Unparalleled 5-Year Guarantee on all parts except the control panel, moving and non-moving, against normal wear and factory defects.

2-Year Guarantee on control panel and handheld remote control unit against normal wear and factory defects.

**YOUR "ONE-STOP" SOURCE FOR AMERICA'S BASEBALL, SOFTBALL & SPORTS SURFACES & SUPPLIES!**

PRICES SUBJECT TO CHANGE & AVAILABILITY PLUS SHIPPING | VOLUME DISCOUNTS AVAILABLE | COOPERATIVE PURCHASING CONTRACT PRICING FOR 50 STATES

# BEAM CLAY®

## WHOLESALE PRICE LIST

Pitching Machines—JUGS

# Changeup Baseball Pitching Machine

For the first time change speeds without the hitter knowing it!

Switch between fastballs and changeups with the touch of a button using the hand-held remote control. Remote control can be used at the machine, behind the hitter or even in the dugout.

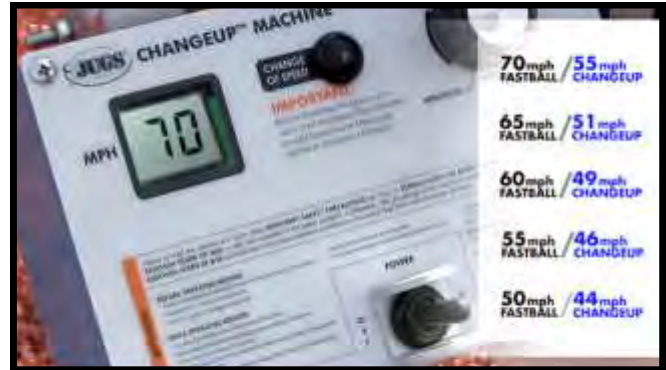

**Realistic 64" delivery height.** Delivers pitches at a realistic downward plane.  
For optimum performance, when using the fastball/changeup mode, your machine must be 37 feet from home plate.



**JUGS NEW 36-Ball  
Carousel Feeder**



Remote control can be used at the machine, behind the hitter or even in the dugout.



**Great for offensive or defensive drills—**

Change the distance of fly balls at the touch of a button—from short pop-ups to long fly balls.

For optional equipment including **JUGS NEW** Carousel Feeder, see page 36.

**YOUR "ONE-STOP" SOURCE FOR AMERICA'S BASEBALL, SOFTBALL & SPORTS SURFACES & SUPPLIES!**

PRICES SUBJECT TO CHANGE & AVAILABILITY PLUS SHIPPING | VOLUME DISCOUNTS AVAILABLE | COOPERATIVE PURCHASING CONTRACT PRICING FOR 50 STATES

# BEAM CLAY®

Pitching Machines—JUGS

**WHOLESALE PRICE LIST**  
 EFFECTIVE: JULY 1, 2021

## BP1 Combo Pitching Machine *for baseball and softball*

*Formally known as the popular JUGS Jr., The NEW BP®1 Combo Pitching Machine has all the features you've come to expect from the JUGS Jr. plus the ability to throw up to 70 mph!*

### BP1—Baseball Only Pitching Machine

Only need the BP®1 for baseball? This is the perfect machine for baseball players advanced enough to hit a 70 mph fastball. #

<b>M1501</b>	<b>BP1 Combo</b>	<b>\$1,735</b>
<b>M1401</b>	<b>BP1 Baseball Only</b>	<b>\$1,680</b>

**NEW higher speed range with consistent strikes, pitch after pitch, year after year.**

**Features, Benefits & Facts:**

Set the JUGS BP®1 to throw at the exact mph you desire—up to 70 mph. With its digital readout display, you decide what precise speed is best for your players.

For baseball: The BP®1 comes with a baseball chute and long straight legs. The BP®1 throws baseballs, Sting-Free® baseballs, Pearl® baseballs, Lite-Flite® baseballs, SOFTIE® baseballs, JUGS BULLDOG™ and tennis balls.

For softball: The BP®1 comes with a 12" softball chute and curved legs. The BP®1 throws 11" or 12" softballs, LeatherLast™ softballs, Sting-Free® softballs, Lite-Flite® softballs, SOFTIE® softballs and JUGS BULLDOG™. Set up for either sport, pitches are thrown from a realistic release point.

Portable and easy to move and set up. Weighs just 75 lbs.

Special non-marking pneumatic tire.

Patented "always see the ball"™ delivery system.

360 Degree Swivel Base— Great for offensive or defensive drills

Runs on 110-volt AC, Yamaha® EF2000iS v2 Inverter Generator or the Complete Practice Battery Pack.

**NEW** Optional Carousel Ball Feeder— See page 36.

Recommended Age	BB 8–15; SB 8–Adult
Speed Range	15–70 mph
Speed Adjustment (mph)	Digital Speed Readout
Pneumatic Tire	Yes
Weight	75 lbs.
360-Degree Swivel	Yes
Power Source	110V AC (see features)
Motors	(1) 1/4 HP, 3 amp
Optional Softball Transport Cart	Yes
Optional Pitching Machine Cover	Yes
<b>NEW</b> Optional Carousel Feeder	Yes
Optional 220V model available	Yes
Optional Field Hockey Conversion Kit	Yes

Unparalleled 5-Year Guarantee on all parts except the control panel, moving and non-moving, against normal wear and factory defects.



- Baseball Only Machine**
- Recommended Skill Level**
  - Pitching Machine Leagues
  - High School
  - College
  - Advanced Travel-Ball
- Speed Range**
  - 15-70 mph

**YOUR "ONE-STOP" SOURCE FOR AMERICA'S BASEBALL, SOFTBALL & SPORTS SURFACES & SUPPLIES!**

PRICES SUBJECT TO CHANGE & AVAILABILITY PLUS SHIPPING | VOLUME DISCOUNTS AVAILABLE | COOPERATIVE PURCHASING CONTRACT PRICING FOR 50 STATES

# BP1 Softball Only Pitching Machine



<b>M1101</b>	<b>BP1 Softball Only</b>	<b>\$1,670</b>
<b>M1106</b>	<b>BP1 With Transport cart</b>	<b>\$1,725</b>

The BP®1 Softball Only Pitching Machine's higher speed range is designed for the advanced player whose skills demand practicing at game-like speeds.

**Features, Benefits & Facts:**

- Higher Speed Range— Throws up to 70 mph.
- Digital readout display
- Throws risers, fastballs and drops.
- Safe and simple to operate. Portable and easy to move and set up. Weighs just 75 lbs.
- Patented "always see the ball"™ delivery system.
- Realistic underhand delivery.
- Throws 11" or 12" softballs, Leather-Last™ softballs, Sting-Free® softballs, Lite-Flite® softballs, SOFTIE® softballs, and JUGS BULLDOG™.
- 360 Degree Swivel Base— Great for offensive or defensive drills
- The BP®1 Softball Only comes standard with a 12" ball chute. An 11" ball chute is sold separately—See page 36.
- Runs on 110-volt AC, Yamaha® EF2000iS v2 Inverter Generator or the Complete Practice Battery Pack.
- NEW** Optional Carousel Ball Feeder— See page 36.

**Softball Only Machine**  
**Recommended Skill Level**  
 High School  
 College  
 Advanced Travel-Ball  
**Speed Range**  
 15-70 mph

Recommended Age	8-Adult
Speed Range	15-70 mph
Speed Adjustment (mph)	Digital Speed Readout
Pneumatic Tire	Yes
Weight	75 lbs.
360-Degree Swivel	Yes
Power Source	110V AC (see features)
Motors	(1) 1/4 HP, 3 amp
Optional Softball Transport Cart	Yes
<i>NOTE: JUGS BP1 Machine with Transport Cart will not throw a dropball.</i>	
Optional Pitching Machine Cover	Yes
<b>NEW</b> Optional Carousel Feeder	Yes
Optional 220V model available	Yes
Optional Field Hockey Conversion Kit	Yes

Unparalleled 5-Year Guarantee on all parts except the control panel, moving and non-moving, against normal wear and factory defects.

**YOUR "ONE-STOP" SOURCE FOR AMERICA'S BASEBALL, SOFTBALL & SPORTS SURFACES & SUPPLIES!**

PRICES SUBJECT TO CHANGE & AVAILABILITY PLUS SHIPPING | VOLUME DISCOUNTS AVAILABLE | COOPERATIVE PURCHASING CONTRACT PRICING FOR 50 STATES

**BEAM CLAY®**

Pitching Machines—JUGS

**WHOLESALE PRICE LIST**  
 EFFECTIVE: JULY 1, 2021

# MVP Combo Pitching Machine *for baseball and softball*



**No walks.  
 No fear of being hit.  
 Lots of action!**

**Features, Benefits & Facts:**

**NEW** higher speed—up to 60 mph.

Set your JUGS MVP® to throw at the exact speed you desire. With its digital readout display, you decide what precise speed is best for your players.

**For baseball:** The MVP® comes with a baseball chute and long straight legs. The MVP® throws baseballs, Sting-Free® baseballs, Pearl® baseballs, Lite-Flite® baseballs, SOFTIE® baseballs, JUGS BULLDOG™ and tennis balls.

**For softball:** The MVP® comes with a 12" softball chute and curved legs. The MVP® throws 11" or 12" softballs, LeatherLast™ softballs, Sting-Free® softballs, Lite-Flite® softballs, SOFTIE® softballs and JUGS BULLDOG™.

Set up for either sport, pitches are thrown from a realistic release point.

Portable and easy to move and set up. Weighs just 56 lbs.

Special non-marking pneumatic tire.

Patented "always see the ball"™ delivery system.

Runs on 110-volt AC, Yamaha® EF2000iS v2 Inverter Generator or the Complete Practice Battery Pack.

**NEW** Optional Carousel Ball Feeder—throws regulation size and weight baseballs or softballs. See page 36.

Recommended Age	8-12
Speed Range	20-60 mph
Speed Adjustment (mph)	Digital Speed Readout
Fly Balls and Pop-ups	Yes
Power Source	110V AC (see features)
Motors	(1) 1/4 HP, 3 amp
Weight	56 lbs.
Pneumatic Tire	Yes
Optional Pitching Machine Cover	Yes
NEW Optional Carousel Feeder	Yes
Optional 220V model available	Yes



**Have you considered starting up a JUGS Pitching Machine League™ in your community? Here's why you should:**

For youngsters just starting out in the game, nothing is better than repetition of fundamental skills.

By using the MVP® Combo Pitching Machine, young ball players get to hone their swings because pitches arrive in virtually the same location each time. That makes the challenge of hitting a little easier and a lot more fun.

Give your players a chance to focus on hitting, fielding and base running by replacing strong pitching with a JUGS Machine. Games played with JUGS machines are easy, safe, fast paced, and fun!

**YOUR "ONE-STOP" SOURCE FOR AMERICA'S BASEBALL, SOFTBALL & SPORTS SURFACES & SUPPLIES!**

PRICES SUBJECT TO CHANGE & AVAILABILITY PLUS SHIPPING | VOLUME DISCOUNTS AVAILABLE | COOPERATIVE PURCHASING CONTRACT PRICING FOR 50 STATES



# BEAM CLAY®

Pitching Machines—JUGS

**WHOLESALE PRICE LIST**  
EFFECTIVE: JULY 1, 2021

## Combination Pitching Machine™ *for baseball and softball*

The Combo Pitching Machine™ is 2 machines in 1—a baseball machine and a softball machine.

Perfect for coaches on a tight budget.

**M1300** Combo Machine

**\$3,905**



### Our most versatile machine:

#### Features, Benefits & Facts:

The Combo's patented QUICK CHANGE™ design lets you switch from baseball to softball in a matter of seconds. The Combo comes with two sets of legs—long straight legs for baseball and tennis, and short curved legs for softball.

Quick and easy speed adjustment.

Portable and easy to move and set up. One person can remove the legs and load JUGS into the trunk of a car.

Patented "gooseneck" design provides full range of movement to adjust for all types of pitches, including fastballs, curves, sliders and split-finger fastballs.

Throws baseballs, 11" or 12" softballs, Sting-Free® balls, Pearl® baseballs, LeatherLast™ softballs, Lite-Flite® balls, SOFTIE® balls, BULL-DOG™ and tennis balls

**GREAT FOR DEFENSIVE DRILLS.** Swivel design base casting provides 360° movement for fly balls, ground balls and pop-ups.

Runs on 110-volt AC, Yamaha® EF2000IS v2 Inverter Generator or the Complete Practice Battery Pack.

Unparalleled 5-Year Guarantee on all parts except the control panel, moving and non-moving, against normal wear and factory defects.

#### Recommended Skill Level

High Schools and Colleges

Professionals

#### Speed Range

20-104 mph

Recommended Age	12—Adult
Speed Range	20–104 mph
Speed Adjustment (mph)	Dual Dial Settings
Power Source	110V AC (see features)
Motors	(2) 1/4 HP, 3 amp
Weight	127 lbs.
360-Degree Swivel	Yes
Pneumatic Tire	Yes
Optional Pitching Machine Cover	Yes
Optional Feeder	Yes
Optional 220V model available	Yes



QUICK CHANGE™ Feeder

**YOUR "ONE-STOP" SOURCE FOR AMERICA'S BASEBALL, SOFTBALL & SPORTS SURFACES & SUPPLIES!**

PRICES SUBJECT TO CHANGE & AVAILABILITY PLUS SHIPPING | VOLUME DISCOUNTS AVAILABLE | COOPERATIVE PURCHASING CONTRACT PRICING FOR 50 STATES

**PARTAC PEAT CORPORATION**  
ONE KELSEY PARK, GREAT MEADOWS, NEW JERSEY 07838

800-247-BEAM (2326) • (908) 637-4191 • FAX (908) 637-8421  
www.beamclay.com • sales@beamclay.com  
Bid Term - 5/9/18 - 5/8/20; Extended to 5/8/21; Extended to 5/8/22

# BEAM CLAY®

Pitching Machines—JUGS

WHOLESALE PRICE LIST  
EFFECTIVE: JULY 1, 2021

## Lite-Flite® Machine for baseball and softball

M6000 Lite-Flite

\$520

**HIGH FUN FACTOR!**

### Recommended Skill Level

- Backyard Players
- Youth Leagues
- High Schools & Colleges

### Speed Range

Simulates pitch speeds up to 85 mph at 25 feet.



2-Year Guarantee on all parts, moving and non-moving, against normal wear and factory defects.

In your backyard, on the field, or in the gym—if your players love to hit, the JUGS Lite-Flite® Machine is perfect for you.

### Features, Benefits & Facts:

Throws Lite-Flite® baseballs, 11" or 12" Lite-Flite® softballs and JUGS BULLDOG™ baseballs and softballs.

JUGS Lite-Flite® Machine provides a full range of movement to adjust for all types of pitches—including fastballs, left- and right-handed curves and sliders. Simulates pitch speeds up to 85 mph at 25 feet.

Quick-Change design features exclusive Switch-and-Play Knobs. Go from baseball to softball in a matter of seconds.

Portable and easy to move and set up. Weighs just 35 lbs.

Swivel-design base casting provides 360° movement for fly balls, ground balls and pop-ups.

Runs on 110-volt AC, JUGS Battery Pack or Yamaha® EF2000iS v2 Inverter Generator.

Recommended Age	8-Adult
Speed Range	15-85 mph
Speed Adjustment (mph)	Single Dial Setting
Pitch Selection	Select-A-Pitch
Power Source	110V AC (see features)
Motors	(1) 1/8 HP, 1.3 amp
Weight	35 lbs.
360-Degree Swivel	Yes
Optional Pitching Machine Cover	Yes
Optional Automatic Feeder	Yes
Optional Feeder Remote Switch	Yes
Optional 220V model available	Yes



### Lite-Flite® Machine throws these pitches:

- Fastballs
- Right-Handed Curves & Sliders
- Left-Handed Curves & Sliders



**YOUR "ONE-STOP" SOURCE FOR AMERICA'S BASEBALL, SOFTBALL & SPORTS SURFACES & SUPPLIES!**

PRICES SUBJECT TO CHANGE & AVAILABILITY PLUS SHIPPING | VOLUME DISCOUNTS AVAILABLE | COOPERATIVE PURCHASING CONTRACT PRICING FOR 50 STATES

# BEAM CLAY®

Pitching Machines—JUGS

WHOLESALE PRICE LIST  
 EFFECTIVE: JULY 1, 2021

## Small-Ball® Pitching Machine

**M7000 Small-Ball \$290**

**Recommended Skill Level**

- Backyard Players
- Youth Leagues
- High Schools & Colleges

**Speed Range**

Simulates pitch speeds up to 75 mph.

1-Year Guarantee on all parts, moving and non-moving, against normal wear and factory defects.



For your convenience, balls can easily be picked up using the plexi extension tube.



The toughest thing to do in sport is hit a round ball with a round bat. Now try it with a bat and ball half the size.

**Features, Benefits & Facts:**

- Throws the JUGS polyurethane-foam 5-inch/1/2-oz. SMALL-BALL®. Sold separately—See page 36.
- Manual and automatic feed: 25-ball feeder releases ball every 5 seconds.
- Adjustable legs for realistic delivery height for both baseball and softball.
- Portable and light-weight—weighs only 23 lbs.
- Simulates speeds up to 75 mph.
- Runs on 110-volt AC, Yamaha® EF2000iS v2 Inverter Generator or the Rechargeable Battery Pack.
- Throws fastballs or overhand curves with uncanny accuracy.
- Great for fly balls and ground balls.
- Safe to use anywhere—backyards, garages or your chosen practice field.



Recommended Age	8-Adult
Steel Construction	Yes
Speed Simulated	Up to 75 mph
Speed Adjustment (mph)	Single Dial Setting
Types of Pitches Thrown	Fastball & Overhand Curveball
Power Source	110V AC (see features)
Manual and Auto Feed	Yes
Weight	23 lbs.
360-Degree Swivel	No
Optional Pitching Machine Cover	Yes
Optional Rechargeable Battery Pack	Yes

**YOUR "ONE-STOP" SOURCE FOR AMERICA'S BASEBALL, SOFTBALL & SPORTS SURFACES & SUPPLIES!**

PRICES SUBJECT TO CHANGE & AVAILABILITY PLUS SHIPPING | VOLUME DISCOUNTS AVAILABLE | COOPERATIVE PURCHASING CONTRACT PRICING FOR 50 STATES

**PARTAC PEAT CORPORATION**  
 ONE KELSEY PARK, GREAT MEADOWS, NEW JERSEY 07838

800-247-BEAM (2326) • (908) 637-4191 • FAX (908) 637-8421  
 www.beamclay.com • sales@beamclay.com  
 Bid Term - 5/9/18 - 5/8/20; Extended to 5/8/21; Extended to 5/8/22

# BEAM CLAY®

Pitching Machines—JUGS

WHOLESALE PRICE LIST  
 EFFECTIVE: JULY 1, 2021

## PS50™ Pitching Machine for baseball and softball

The PS50™ is great for baseball and fastpitch softball. It even throws perfect arcing tosses for slowpitch softball.



M1150 PS50 \$865

### The PS50™ features a NEW digital readout display.

#### Features, Benefits & Facts:

Set the JUGS PS50™ to throw at the exact mph you desire—up to 50 mph. With its NEW digital readout display, you decide what precise speed is best for your players.

**For baseball:** The PS50™ comes with a baseball chute and long straight legs. The PS50™ throws baseballs, Sting-Free® baseballs, Pearl® baseballs, Lite-Flite® baseballs, SOFTIE® baseballs, JUGS BULLDOG™ and tennis balls.

**For softball:** The PS50™ comes with a 12" softball chute and curved legs. The BP®1 throws 11" or 12" softballs, LeatherLast™ softballs, Sting-Free® softballs, Lite-Flite® softballs, SOFTIE® softballs and JUGS BULLDOG™.

Set up for either sport, pitches are thrown from a realistic release point.

Portable and easy to move and set up. 50 lb. solid-steel construction.

Special non-marking 9" pneumatic tire.

Patented "always see the ball"™ delivery system.

**NEW** Quick-Snap® legs

Grip-n-Go™ handle for easy transport.

Throws fly balls and ground balls.

Runs on 110-volt AC, Yamaha® EF2000iS v2 Inverter Generator or the Complete Practice Battery Pack.

**NEW** Optional Carousel Ball Feeder—throws regulation size and weight baseballs or softballs. See page 36.

1-Year Guarantee on all parts, moving and non-moving, against normal wear and factory defects.



Recommended Age	8–13
Guarantee	1 Year
Speed Range	15–50 mph
Speed Adjustment (mph)	Digital Speed Readout
Power Source	110V AC (see features)
Motors	(1) 1/4 HP, 3 amp
Weight	50 lbs.
360-Degree Swivel	No
Pneumatic Tire	Yes
Optional Pitching Machine Cover	Yes
<b>NEW</b> Optional Carousel Feeder	Yes
Optional 220V model available	No

#### Recommended Skill Level

Backyard Players

Youth Leagues

#### Speed Range

15–50 mph

**ALL, SOFTBALL & SPORTS SURFACES & SUPPLIES!**

PRICES SUBJECT TO CHANGE & AVAILABILITY PLUS SHIPPING | VOLUME DISCOUNTS AVAILABLE | COOPERATIVE PURCHASING CONTRACT PRICING FOR 50 STATES

**BEAM CLAY®**

Pitching Machines—JUGS

**WHOLESALE PRICE LIST**  
EFFECTIVE: JULY 1, 2020

# Toss™ Machine for baseball and softball



A0600

\$260

**Get hundreds of swings in less than half an hour.**

**Features, Benefits & Facts:**

- Automatically tosses a ball every 5 seconds. Get hundreds of swings in less than half an hour.
- Holds up to 14 baseballs or 10 softballs. Balls sold separately.
- Will toss any regulation size and weight baseball or softball.
- Weighs just 13 lbs.
- No electricity needed for up to 8 hours of continuous use. Comes with internal rechargeable battery (charger included.)
- Tosses 11" or 12" softballs, baseballs, Pearl® baseballs, Sting-Free® balls, Lite-Flite® balls, Softie® balls and the JUGS Bulldog polyballs.
- Great for offensive or defensive drills.
- FREE 24-page Toss™ Machine Drill Book and Throw-Down Home Plate.

2-Year Guarantee on all parts, moving and non-moving, against normal wear and factory defects.

**Recommended Skill Level**

- Backyard Players
- Youth Leagues
- High Schools and Colleges
- Professionals

Recommended Age	5-Adult
Speed Adjustment	Automatic every 5 seconds
Power Source	Rechargeable
Weight	13 lbs.
Rechargeable	Yes
Optional 220V model available	Yes



**ALL, SOFTBALL BATTERING PRACTICE & SUPPLIES!**

PRICES SUBJECT TO CHANGE & AVAILABILITY PLUS SHIPPING | VOLUME DISCOUNTS AVAILABLE | COOPERATIVE PURCHASING CONTRACT PRICING FOR 50 STATES

**PARTAC PEAT CORPORATION**  
ONE KELSEY PARK, GREAT MEADOWS, NEW JERSEY 07838

800-247-BEAM (2326) • (908) 637-4191 • FAX (908) 637-8421  
www.beamclay.com • sales@beamclay.com  
Bid Term - 5/9/18 - 5/8/20; Extended to 5/8/21; Extended to 5/8/22

# BEAM CLAY®

Pitching Machines—JUGS

WHOLESALE PRICE LIST  
EFFECTIVE: JULY 1, 2021

## Automatic Ball Feeders

**NEW CAROUSEL FEEDER**  
Hitting on your own has never been easier



For Baseball



For Softball



Perfect for indoor practice.



Holds 36 baseballs or 18 softballs.



Heavy-duty steel and Lexan Construction.

- Releases a ball every 6 seconds.
- Heavy-duty steel and Lexan construction.
- Holds 36 baseballs or 18 softballs.
- Can be used with any regulation size and weight baseball or softball.
- Easy to set up.
- Runs on 110V AC.
- Works with in-line Feeder Remote Switch (sold separately.)

<b>F1045</b>	18-Softball Carousel Feeder: Works with all JUGS Softball machines past and present except the 2-wheel Combo.	<b>\$605</b>
<b>F1050</b>	36-Baseball Carousel Feeder: BP1 Baseball Only, Changeup Baseball, PS50, Jr Baseball, MVP Baseball.	<b>\$605</b>
<b>F1065</b>	36-Baseball Carousel Feeder: BP3	<b>\$605</b>
<b>F1055</b>	36-Baseball and 18-Softball Carousel Feeder: BP1 Combo, MVP Combo, Jr Baseball/Softball	<b>\$650</b>

**YOUR "ONE-STOP" SOURCE FOR AMERICA'S BASEBALL, SOFTBALL & SPORTS SURFACES & SUPPLIES!**

PRICES SUBJECT TO CHANGE & AVAILABILITY PLUS SHIPPING | VOLUME DISCOUNTS AVAILABLE | COOPERATIVE PURCHASING CONTRACT PRICING FOR 50 STATES

**PARTAC PEAT CORPORATION**  
ONE KELSEY PARK, GREAT MEADOWS, NEW JERSEY 07838

800-247-BEAM (2326) • (908) 637-4191 • FAX (908) 637-8421  
www.beamclay.com • sales@beamclay.com  
Bid Term - 5/9/18 - 5/8/20; Extended to 5/8/21; Extended to 5/8/22

# BEAM CLAY®

Pitching Machines—JUGS

WHOLESALE PRICE LIST  
EFFECTIVE: JULY 1, 2021

## Feeders for JUGS Lite-Flite and 2-Wheel Combo Machines



**F1030** 14-Ball Lite-Flite Softball Feeder **\$260**



**F1025** 18-Ball Lite-Flite Baseball Feeder **\$260**



**F1040** 24-Ball Lite-Flite LaCrosse Feeder **\$260**

- Portable and lightweight.
- Simple to set up and operate.
- Delivers a ball every 6 seconds.
- Made of durable lightweight steel.

**IMPORTANT:** A protective screen must be used to protect machine and feeder from batted balls.



**F1020** 14-Ball Combo Softball Feeder **\$690**



**F1000** 18-Ball Combo Baseball Feeder **\$690**



**F3000** In-Line Feeder Remote Switch—Works with all JUGS Feeders **\$145**

**YOUR “ONE-STOP” SOURCE FOR AMERICA’S BASEBALL, SOFTBALL & SPORTS SURFACES & SUPPLIES!**

PRICES SUBJECT TO CHANGE & AVAILABILITY PLUS SHIPPING | VOLUME DISCOUNTS AVAILABLE | COOPERATIVE PURCHASING CONTRACT PRICING FOR 50 STATES

**PARTAC PEAT CORPORATION**  
ONE KELSEY PARK, GREAT MEADOWS, NEW JERSEY 07838

800-247-BEAM (2326) • (908) 637-4191 • FAX (908) 637-8421  
www.beamclay.com • sales@beamclay.com  
Bid Term - 5/9/18 - 5/8/20; Extended to 5/8/21; Extended to 5/8/22

# BEAM CLAY®

## WHOLESALE PRICE LIST EFFECTIVE: JULY 1, 2021

Pitching Machines—JUGS

### ACCESSORIES

Buckets and Ball Holders:



**Ball Pouch:**

- Convenient ball storage.
- Holds 48 baseballs or 36 softballs (balls not included).
- Easily attaches to your protective screen or batting cage.

**A0020** Ball Pouch **\$11.55**



**Back-Saver™ Ball Basket:**

- A collapsible ball basket—great for holding balls during practice.
- Holds up to 100 baseballs or 60 softballs. (balls not included).
- Light-weight and durable.

**A1021** Back-Saver™ Ball Basket **\$71.50**



**Bucket Plus:**

- Bucket & balls not included.*
- A portable stand used to elevate your bucket of balls. Saves you the constant bending over.
- Easy to use—just place your bucket of balls in it and you're ready to go.

**A1030** Bucket Plus **\$52**



**Bucket with Lid:**

- No spilled balls in your trunk or back seat.
- Holds 60 baseballs or 30 softballs. (balls not included).
- Makes a great coaching seat.

**A2030** Albert Pujols **\$17.50**  
**A2031** Michele Smith **\$17.50**

### Portable Power Supplies:

Operate your machine away from 110V AC power using one of JUGS Portable Power Supplies.

- The Yamaha®EF2000iS v2 Inverter Generator will work on all JUGS machines.
- The Complete Practice Battery Pack works on all JUGS machines except the BP@3, Changeup Super Softball and Changeup Baseball.
- The Rechargeable Battery Pack is the perfect addition to both the Lite-Flite® and Small-Ball® machines.



Yamaha®EF2000iS v2 Inverter Generator

**A2001** **\$1,250**



Rechargeable Battery Pack

**A0050** **\$305**



Complete Practice™ Battery Pack

**A0055** **\$1,030**

### Machine Covers:

- Heavy Duty Vinyl Construction.
- One size fits all JUGS machines.
- Rope and grommets for tightening around machine.
- Protects your machine from the elements and damage that can occur from exposure.



Pitching Machine Cover

**A0015** **\$85**

### Options:

- Softball Transport Cart **A0702** **\$240**
- 11-Inch Feed Chute **53025** **\$50**
- Hitting Stick™ **A1010** **\$28**
- Hitting Stick™ Package **A1000** **\$47**
- Small-Ball® Instant Protective Screen **S0200** **\$85**



PRICES SUBJECT TO CHANGE & AVAILABILITY PLUS SHIPPING | VOLUME DISCOUNTS AVAILABLE | COOPERATIVE PURCHASING CONTRACT PRICING FOR 50 STATES



**BEAM CLAY®**

Pitching Machines—JUGS

**WHOLESALE PRICE LIST**  
 EFFECTIVE: JANUARY 1, 2021

# JUGS Hitting Package

Albert Pujols Baseball Backyard Package™

**A0001**

**\$4,725**

"Taking batting practice off a JUGS machine will give you the confidence you'll need to face the toughest of pitchers, no matter what league you play in."

— Albert Pujols,  
 2001 Rookie of the Year,  
 2005, 2008 & 2009 N.L. MVP



**Albert Pujols Baseball Backyard Package Includes:**

- NEW BP®2 Baseball Pitching Machine
- Backyard Batting Cage™ #7, #27 Breaking-Strength (11' x 11' x 65')
- Outdoor Frame for Batting Cage #7
- Fixed-Frame™ L-Shaped Screen
- Back-Saver™ Ball Basket
- 4-Dozen Yellow Dimpled Sting-Free® Baseballs
- FREE Backdrop and Pitcher's Trainer

Please note that this package cannot be shipped 1,2 or 3 day air. Allow 12-20 days for Frame Shipment.



**YOUR "ONE-STOP" SOURCE FOR AMERICA'S BASEBALL, SOFTBALL & SPORTS SURFACES & SUPPLIES!**

PRICES SUBJECT TO CHANGE & AVAILABILITY PLUS SHIPPING | VOLUME DISCOUNTS AVAILABLE | COOPERATIVE PURCHASING CONTRACT PRICING FOR 50 STATES

**PARTAC PEAT CORPORATION**  
 ONE KELSEY PARK, GREAT MEADOWS, NEW JERSEY 07838

800-247-BEAM (2326) • (908) 637-4191 • FAX (908) 637-8421  
 www.beamclay.com • sales@beamclay.com  
 Bid Term - 5/9/18 - 5/8/20; Extended to 5/8/21; Extended to 5/8/22

**BEAM CLAY®**

Pitching Machines—JUGS

**WHOLESALE PRICE LIST**  
 EFFECTIVE: JULY 1, 2021

# JUGS Hitting Package

Michelle Smith Softball Backyard Package™

**A0002**

**\$3,355**

" I attribute much of my hitting success to the consistency of the JUGS machines. JUGS Softball Machines has given me constant trouble-free practices for years. Every young softball player should make a JUGS machine part of their daily practice routine."  
 — Michele Smith,  
 2-time Olympic Gold Medalist



## Michele Smith Softball Backyard Package™

Package Includes:

- NEW BP®1 Softball Only Pitching Machine
- 55'L x 12'W x 12'H Batting Cage Net, #27 Polyethylene
- Required Assembly Space: (59'L x 16'W x 12'H)
- Frame for 55'L x 12'W x 12'H Cage
- FIXED FRAME™ Softball Screen
- FREE Backdrop & Pitcher's Trainer
- Back-Saver™ Ball Basket
- (3) Dozen Game-Ball™ Yellow Dimpled Sting-Free® Softballs



**YOUR "ONE-STOP" SOURCE FOR AMERICA'S BASEBALL, SOFTBALL & SPORTS SURFACES & SUPPLIES!**

PRICES SUBJECT TO CHANGE & AVAILABILITY PLUS SHIPPING | VOLUME DISCOUNTS AVAILABLE | COOPERATIVE PURCHASING CONTRACT PRICING FOR 50 STATES

**PARTAC PEAT CORPORATION**  
 ONE KELSEY PARK, GREAT MEADOWS, NEW JERSEY 07838

800-247-BEAM (2326) • (908) 637-4191 • FAX (908) 637-8421  
 www.beamclay.com • sales@beamclay.com  
 Bid Term - 5/9/18 - 5/8/20; Extended to 5/8/21; Extended to 5/8/22

**BEAM CLAY®**

Pitching Machines—JUGS

**WHOLESALE PRICE LIST**  
 EFFECTIVE: JULY 1, 2021

# JUGS Hitting Package



## NEW Hit at Home® Backyard Package

Package Includes:

- NEW Hit at Home Backyard Batting Cage (45'L x 11'W x 11'H)
- Required Assembly Space: (57'L X 27'W X 11'H)
- PS50™ Pitching Machine for Baseball and Softball
- Lite-Flite/Slowpitch Quick-Snap® Protective Screen
- 1 Dozen Pearl® Baseballs or 1 Dozen Game-Ball™
- Yellow dimpled Sting-Free® Softballs

Baseball **A0320**

**\$1,975**

Softball **A0325**

**\$1,945**



**YOUR "ONE-STOP" SOURCE FOR AMERICA'S BASEBALL, SOFTBALL & SPORTS SURFACES & SUPPLIES!**

PRICES SUBJECT TO CHANGE & AVAILABILITY PLUS SHIPPING | VOLUME DISCOUNTS AVAILABLE | COOPERATIVE PURCHASING CONTRACT PRICING FOR 50 STATES

**PARTAC PEAT CORPORATION**  
 ONE KELSEY PARK, GREAT MEADOWS, NEW JERSEY 07838

800-247-BEAM (2326) • (908) 637-4191 • FAX (908) 637-8421  
 www.beamclay.com • sales@beamclay.com  
 Bid Term - 5/9/18 - 5/8/20; Extended to 5/8/21; Extended to 5/8/22

**BEAM CLAY®**

Pitching Machines—JUGS

**WHOLESALE PRICE LIST**  
EFFECTIVE: JULY 1, 2021

# JUGS Hitting Package



## Youth League Package™

Package Includes:

NEW BP®1 Combo Pitching Machine for Baseball and Softball

Portable Free-Standing Sports Cage™ (50'L x 11'W x 11'H)

*Required Assembly Space: (55'L X 12'W X 12'H)*

FREE Backdrop &amp; Pitcher's Trainer

(3) Dozen Yellow Dimpled Sting-Free® Baseballs

(3) Dozen Game-Ball™ Yellow Dimpled Sting-Free® Softballs

Your choice of either the™ L-Shaped or Softball Screen

**A0007****\$3,735****YOUR “ONE-STOP” SOURCE FOR AMERICA’S BASEBALL, SOFTBALL & SPORTS SURFACES & SUPPLIES!**

PRICES SUBJECT TO CHANGE &amp; AVAILABILITY PLUS SHIPPING | VOLUME DISCOUNTS AVAILABLE | COOPERATIVE PURCHASING CONTRACT PRICING FOR 50 STATES

**PARTAC PEAT CORPORATION**  
ONE KELSEY PARK, GREAT MEADOWS, NEW JERSEY 07838**800-247-BEAM (2326) • (908) 637-4191 • FAX (908) 637-8421**  
**www.beamclay.com • sales@beamclay.com**  
Bid Term - 5/9/18 - 5/8/20; Extended to 5/8/21; Extended to 5/8/22

# BEAM CLAY®

Pitching Machines—JUGS

**WHOLESALE PRICE LIST**  
EFFECTIVE: JULY 1, 2021

## JUGS Batting T Hitting Stations



### JUGS® T Hitting Station

Package Includes:

- JUGS T
- JUGS® Short T
- Travel Screen
- 1-Dozen Pearl® Baseballs or Seamed Softballs
- Throw-Down Home Plate

Baseball <b>A0086</b>	<b>\$425</b>
Softball <b>A0096</b>	<b>\$395</b>



### 5-Point Hitting Tee™ Package

Package Includes:

- Redesigned Instant Screen®
- 5-Point Hitting Tee™
- 2-Dozen Sting-Free® Baseballs or Softballs

Baseball <b>A0110</b>	<b>\$345</b>
Softball <b>A0210</b>	<b>\$360</b>



### Practice Package™

Package Includes:

- Redesigned Instant Screen®
- HIT LIKE A PRO Hitting Tee™
- 2-Dozen Sting-Free® Baseballs or Softballs

Baseball <b>A0100</b>	<b>\$285</b>
Softball <b>A0200</b>	<b>\$305</b>



### Toss Package™

Package Includes:

- Redesigned Instant Screen®
- Toss™ Machine
- Throw-down Home Plate
- Toss™ Machine Drill Book
- 2-Dozen Sting-Free® Baseballs or Softballs

Baseball <b>A0150</b>	<b>\$480</b>
Softball <b>A0250</b>	<b>\$480</b>

**YOUR "ONE-STOP" SOURCE FOR AMERICA'S BASEBALL, SOFTBALL & SPORTS SURFACES & SUPPLIES!**

PRICES SUBJECT TO CHANGE & AVAILABILITY PLUS SHIPPING | VOLUME DISCOUNTS AVAILABLE | COOPERATIVE PURCHASING CONTRACT PRICING FOR 50 STATES

# BEAM CLAY®

Pitching Machines—JUGS

**WHOLESALE PRICE LIST**  
EFFECTIVE: JULY 1, 2021



## Small-Ball® Pitching Machine Package

Package includes:

- Small-Ball® Machine
- Small-Ball® Instant Protective Screen
- Hitting Stick
- 4-Dozen Small-Balls
- Throw-Down Home Plate
- FREE Drill Book

**A0060**

**\$435**



## Short-Toss® Package

Package includes:

- Multi-Sport Instant Cage® (12'L x 12'W x 9'H)
- FIXED FRAME™ Short-Toss® Screen
- (4) Dozen JUGS Pearl® Baseballs with Pujols Bucket
- Back-Saver™ Ball Basket
- Throw-Down Home Plate

**A0008**

**\$1,425**



## Baseball Backyard Net Package

Package includes:

- 65'L x 11'W x 11'H Batting Cage™ Net, #27 Polyethylene
- Required Assembly Space: (69'L X 15'W X 11'H)*
- Outdoor Frame for 65'L x 11'W x 11'H Cage
- FIXED FRAME™ L-Shaped Screen
- FREE Backdrop & Pitcher's Trainer

**A0005**

**\$1,800**



## Softball Backyard Net Package

Package includes:

- 55'L x 12'W x 12'H Batting Cage™ Net, #27 Polyethylene
- Required Assembly Space: (59'L X 16'W X 12'H)*
- Outdoor Frame for 55'L x 12'W x 12'H Cage
- FIXED FRAME™™ Softball Screen
- FREE Backdrop & Pitcher's Trainer

**A0006**

**\$1,755**

**YOUR "ONE-STOP" SOURCE FOR AMERICA'S BASEBALL, SOFTBALL & SPORTS SURFACES & SUPPLIES!**

PRICES SUBJECT TO CHANGE & AVAILABILITY PLUS SHIPPING | VOLUME DISCOUNTS AVAILABLE | COOPERATIVE PURCHASING CONTRACT PRICING FOR 50 STATES

# BEAM CLAY®

Pitching Machines—Iron Mike

**WHOLESALE PRICE LIST**  
EFFECTIVE: JANUARY 1, 2021



## Why Choose Arm-Style Pitching Machines?

Hitting is all about timing. You must have the proper timing to know when to start your swing and when to shift your weight. This is achieved by watching the pitcher's arm and release of the ball. An arm-style pitching machine is the only type of pitching machine that gives you that same sense of timing. With each pitch you see the machine's arm wind up and release the ball. It is the realistic nature of the machine that allows you to practice the same fundamentals in the batting cages as you use on the field. Because of this, the Iron MikeT arm-style pitching machines from Master Pitching Machine are the favorite machines of professional players and coaches worldwide.



### HOPPER-FED PITCHING MACHINES

- Hopper-fed 600 baseball or 400 softball capacity
- Heavy-duty arm and hand system
- Easily converted from baseball to softball
- Built-in low voltage remote control
- Hold-down clips for permanent installation
- Lockable arm guard cover
- Electrically powered - 115 A.C. motor

**#761-102**

**Model MP-6**  
57"Hx44"Wx59"L (Shipping Wt. 610 lbs.)

**\$4,650**

**#762-563**

### **POSITIVE FEED CONTROL UNIT**

For use with the MP-6. Ensures that seamed balls will flow properly. It is a standard feature on the MP-4.

**\$215**



### **The Favorite of Major League Teams!!!**

The MP-4 is our top of the line hopper-fed machine that has the same features of the MP-6 with these added benefits:

- Extra reinforcements on the frame of the machine to protect against batted balls.
- Includes our Positive Feed Control which ensures good ball flow when using seamed balls.

**#761-103**

**Model MP-4**  
57"Hx44"Wx59"L (Shipping Wt. 625 lbs.)

**\$5,195**



### RACK-FED PITCHING MACHINES

- Ball rack fed - 38 baseball or 28 softball capacity
- Heavy-duty arm and hand system
- Easily converted from baseball to softball
- Built-in low voltage remote control with 80-foot cord
- 4-wheel transport for quick, easy moving
- Lockable arm guard cover
- Electrically powered - 115 volt A.C. motor

**#761-104**

**Model MP-5**  
56"Hx30"Wx55"L (Shipping Wt. 480 lbs.)

**\$3,895**

**#762-600**

### **Ball Feed Enhancer Unit**

For use with the MP-5.  
Ensures that seamed balls will flow properly.

**\$155**

**YOUR "ONE-STOP" SOURCE FOR AMERICA'S BASEBALL, SOFTBALL & SPORTS SURFACES & SUPPLIES!**

PRICES SUBJECT TO CHANGE & AVAILABILITY PLUS SHIPPING | VOLUME DISCOUNTS AVAILABLE | COOPERATIVE PURCHASING CONTRACT PRICING FOR 50 STATES

# BEAM CLAY®

Pitching Machines—Iron Mike

**WHOLESALE PRICE LIST**  
 EFFECTIVE: JANUARY 1, 2021



**MODEL**  
**C-82**  
 Great Starter  
 Machine  
 20-60 mph

**COMPACT, INEXPENSIVE TRAINER FOR THE KIDS\***

Also Ideal for Slow-Pitch Softball

- Designed for on-field or backyard practice
- Ball rack fed - 25 baseball or 20 softball capacity
- Will throw baseballs, softballs, and polyballs
- 2-wheel system for quick, easy moving
- Lockable arm guard cover
- Electrically powered - 115 volt A.C. motor

\*Not recommended for high school baseball or fast pitch softball programs.

**#762-006**

**Model C-82**  
 36"Hx20"Wx36"L (Shipping St. 175 lbs.)

**\$1,855**

**#762-013**

**REMOTE CONTROL WITH 80' CORD**

**\$180**

Adds the ability to start and stop the machine from the batter's area  
 (Shipping Wt. 14 lbs.)

*Standard on all machines except the C-82.*



## COVERS

- Helps Extend Life of Machine
- Made of Heavy, Waterproof Nylon
- Full Length Coverage
- Custom Fitted

C-53/MP-5 Cover

**#762-560**

**\$235**

C-55/MP-4/MP-6 Cover

**#762-561**

**\$275**

**YOUR "ONE-STOP" SOURCE FOR AMERICA'S BASEBALL, SOFTBALL & SPORTS SURFACES & SUPPLIES!**

PRICES SUBJECT TO CHANGE & AVAILABILITY PLUS SHIPPING | VOLUME DISCOUNTS AVAILABLE | COOPERATIVE PURCHASING CONTRACT PRICING FOR 50 STATES



# BEAM CLAY®

Aluminum Batting Practice Screens

WHOLESALE PRICE LIST  
 EFFECTIVE: JULY 1, 2021

## PROFESSIONAL PROTECTIVE SCREENS



- Oversized 8' - 10' for Maximum Protection
- Heavy Wall Aluminum Construction
- Slip-Over Pillow Case (3.0 mm) Nylon Net Included
- Pneumatic Tires for Easy Transporting

### PRO BASE/FUNGO SCREENS

- Frames are heavy wall schedule 40 aluminum 1.9" O.D. pipe
- Large 10" x 4" pneumatic tires for easy transport
- Netting is #60 (3 mm) weather treated, 1-3/4" mesh fabricated in pillow case style that slip over frames.
- Lacing is only required at the bottom to close the net.

#BSFPRO8	8' High x 8' Wide, 47 lbs.	\$755
#1148596	Replacement Net, 7 lbs.	\$300
#BSFPRO10	10' High x 10' Wide, 54 lbs.	\$860
#1148619	Replacement Net, 9 lbs.	\$300



### PROFESSIONAL L-SCREEN

- Oversized 8' x 8' L-Shaped with extra diagonal hip protection in the corner. (Ricochet padding not included — see page 2 for Ricochet Padding options)
- Constructed of heavy wall schedule 40 aluminum 1.9" O.D. pipe
- Complete with #60 (3 mm) pillow case style weather treated net
- Large 10" x 4" pneumatic tires for easy transport

#BSPROL	L-SCREEN (Aluminum)	\$775
#1148572	Replacement Net, 5 lbs.	\$300
#BSPROLS	L-Screen (Steel)	\$775



### PRO TRI-FOLD FUNGO SCREEN

- Middle Screen is 8' x 8' with two 8' x 4' wings provides overall 8'H x 16'W protection area
- Frame is heavy wall schedule 40 aluminum 1.9" O.D. pipe
- Netting is #60 (3 mm) weather treated, 1-3/4" mesh - fabricated in pillow case style that slip over frames
- Includes two solid (not pneumatic) 8" transport wheels.
- Wings easily fold in for transport & storage
- Ideal for 2nd Base/Infield protection
- 3 Year Limited Warranty

#BSFR016	Complete Unit 8'H x 16'W	\$1,190
#1148596	Replacement Net—Middle Section	\$300
#1265279	Repl. Net Side Wings (sold in pairs)	\$319/PR

**YOUR "ONE-STOP" SOURCE FOR AMERICA'S BASEBALL, SOFTBALL & SPORTS SURFACES & SUPPLIES!**

PRICES SUBJECT TO CHANGE & AVAILABILITY PLUS SHIPPING | VOLUME DISCOUNTS AVAILABLE | COOPERATIVE PURCHASING CONTRACT PRICING FOR 50 STATES

# BEAM CLAY®

## WHOLESALE PRICE LIST EFFECTIVE: JULY 1, 2021

### Batting Practice Screens

### COLLEGIATE PROTECTIVE SCREENS

Heavy-duty 1-1/2" square galvanized steel frames for extra rigidity. Frames are all 7'High x 7'Wide. Nets are #36 heavy-duty weather treated polyethylene construction. Nets are double-sided pillow case construction and slip over frames.



**WHEEL KIT**  
For use on all units. 6" poly wheels with steel brackets

**BSWKIT**

**\$88**



**PITCHER'S PROTECTOR**  
Heavy duty 1-1/2" square 17 gauge galvanized steel frame. 7'H x 7'W. Cutout is 3-1/2' x 3-1/2'. Covered with black heavy-duty weatherproof slip-on #36 polyethylene netting. Comes with slip-on net. Wt. 42 lbs.

**COMPLETE UNIT**

**1399586** **\$280**

**REPL. SLIP-ON NET** (pillow case)

**BS47743NET** **\$172**



**SOCK NET W/FRAME**  
Suitable for batting drills and pitching drills. Protective screen is 7'H x 7'W with 42" square sock. 1-1/2" square galvanized steel frame with swaged joints; frames slip together. Pillowcase-style double #36 polyethylene netting.

**COMPLETE UNIT**

**1399597** **\$365**

**REPLACEMENT SLIP-ON NET**

**BS47700NET** **\$215**



**FIRST BASE/FUNGO PROTECTOR**  
Heavy duty 1-1/2" square 17 gauge galvanized steel frame allows for extra rigidity. 7'H x 7'W. Covered with black heavy-duty weatherproof slip-on #36 polyethylene netting. Comes with slip-on net. Wt. 42 lbs.

**COMPLETE UNIT**

**1399589** **\$345**

**REPL. 7x7 SLIP-ON NET** (pillow case)

**BS47710NET** **\$150**



**SOFTBALL PITCHER PROTECTOR**  
Heavy duty 1-1/2" square galvanized steel frame with swaged joints for extra rigidity 7'H x 7'W. Comes with pillowcase style double #36 polyethylene net w/hole cutout for softball delivery. Works with pitching machine or live-arm delivery.

**COMPLETE UNIT**

**1399588** **\$325**

**REPLACEMENT SLIP-ON NET**

**BS47750NET** **\$180**



**C-SHAPED PITCHER'S PROTECTOR**  
• Heavy-duty 1 1/2" square 17 gauge galvanized steel  
• Frames are 7' H x 7' W  
• 2.5mm twisted knotted polyethylene slip-on pillow case style net

**COMPLETE UNIT**

**1453177** **\$280**

**REPLACEMENT NET**

**1366836N** **\$195**



**L-SCREEN W/HOOD**  
• Heavy-duty 1 1/2" square 17 gauge galvanized steel  
• Frames are 7' H x 7' W  
• 2.5mm twisted knotted polyethylene slip-on pillow case style net

**COMPLETE UNIT**

**1453178** **\$360**

**REPLACEMENT NET**

**1378703** **\$180**

**NET REPAIR/LACING CORDS**  
Black Poly Twine

**#1236743** 100' Spool—3mm **\$21.50**



**MINI L SCREEN**  
• Unit is 5'W x 7'H  
• Perfect for batting practice or inside batting tunnels.  
• Constructed of heavy wall schedule 40 aluminum tubing.  
• Complete with 3.0mm pillow case style weather treated net.  
• Large 4" x 10" no flat tires for smooth and easy transport.  
• Free padding on the "throwing zone" for added safety.  
• **3 Year Limited Warranty**

**#BSFPRO5** Complete Unit **\$569**

**#1296464** Replacement Net **\$219**

**YOUR "ONE-STOP" SOURCE FOR AMERICA'S BASEBALL, SOFTBALL & SPORTS SURFACES & SUPPLIES!**

PRICES SUBJECT TO CHANGE & AVAILABILITY PLUS SHIPPING | VOLUME DISCOUNTS AVAILABLE | COOPERATIVE PURCHASING CONTRACT PRICING FOR 50 STATES

# BEAM CLAY®

## WHOLESALE PRICE LIST EFFECTIVE: JULY 1, 2021

### Batting Practice Screens & Ball Bin / Carts



### HITTING STATION

Perfect for hitting practice - whether off of a tee or taking soft toss  
2-3/8" diameter galvanized steel construction  
Installed dimensions are 10'H x 11'W x 1 1/2" D  
Net is 1.75" mesh #504 knotless HTTP  
Cable along the bottom of net keeps the ball contained  
Can be installed permanently or semi permanent with provided ground sleeves  
Turf mat and concrete not included

#### 5 Year Limited

#BBHITSTA Complete Unit **\$745**



### ADJUSTABLE FIELD BALL CART

- Aluminum frame with heavy duty molded plastic hopper and large rear wheels for easy mobility.
- Legs are height adjustable to raise or lower hopper height.
- Holds 200 baseballs/100 softballs

#1237207 **\$595**



### BATTING PRACTICE BALL CART

- Constructed of heavy duty 1.5" OD powder coated steel
- Large capacity basket is 15"W x 15"L x 15"D
- Holds approx. 120 baseballs or 60 softballs
- Oversized No-flat tires

#1378683 **\$240**

### REPLACEMENT WHEEL

#1375102 **\$30**



### FOLDABLE BALL BIN

- Waist high ball bin-ideal for soft toss or normal BP
- Foldable design allows for easy storage
- Holds over 100 baseballs or over 50 softballs

#1361841 **\$90**

**YOUR "ONE-STOP" SOURCE FOR AMERICA'S BASEBALL, SOFTBALL & SPORTS SURFACES & SUPPLIES!**

PRICES SUBJECT TO CHANGE & AVAILABILITY PLUS SHIPPING | VOLUME DISCOUNTS AVAILABLE | COOPERATIVE PURCHASING CONTRACT PRICING FOR 50 STATES

# BEAM CLAY®

**WHOLESALE PRICE LIST**  
 EFFECTIVE: JULY 1, 2021

Batting Practice Ball Cart, Bat Rack, Ball Holder



## PROCAGE™ Professional Ball Cart

Features HD powder-coated steel frame with a premium mesh netted ball basket. Sturdy and durable with no-flat turf tires protect playing surface. Push-button for easy assembly. Dolly-style design for easy transport. Cart holds 300 baseballs and approximately 150 softballs. Perfect for all levels of play.

#BPCADP	Professional Ball Cart	\$217
#BPCADPN	Replacement Net	\$39

## BATTING PRACTICE BALL CADDY

Ball Caddy can be used sitting or standing by easily adjusting the leg height. Comes with wheels for easy transport on & off the field. Caddy holds 60 baseballs or 36 softballs. Dimensions for the ball caddy: 18" Wide at top & bottom. Caddy adjusts from 36" at the highest point to 30" and then 24" at the lowest point.

#BPCAD	Batting Practice Ball Caddy	\$112
#BPCADMB	Replacement Bag	\$30.50



## HANGING BAT RACK

All steel construction powder coated black for maximum protection. Hanging arms swivel for easy use and storage. Rack holds 10 bats. Size: 30" wide.

#BHRACK	Hanging Bat Rack	\$35
---------	------------------	------

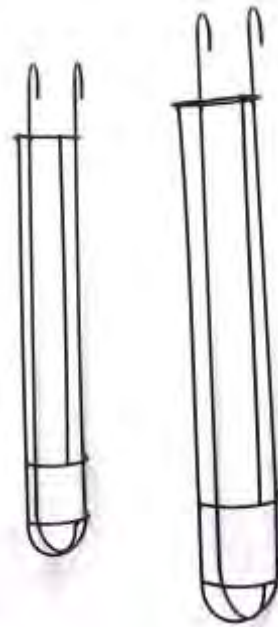

## HANGING BALL HOLDER

All steel, welded construction powder coated black. Holders store up to 10 balls.

#BBHLD	Baseballs	\$25
#SBHLD	Softballs	\$25

**YOUR "ONE-STOP" SOURCE FOR AMERICA'S BASEBALL, SOFTBALL & SPORTS SURFACES & SUPPLIES!**

PRICES SUBJECT TO CHANGE & AVAILABILITY PLUS SHIPPING | VOLUME DISCOUNTS AVAILABLE | COOPERATIVE PURCHASING CONTRACT PRICING FOR 50 STATES

# BEAM CLAY®

ProCage Professional Screens

WHOLESALE PRICE LIST  
EFFECTIVE: JULY 1, 2021



## ProCage™ Professional Screens



#96 NETTING



### PROCAGE™ “OLE 96er” PRO L-SCREEN

**Features:**

- Size: 8' x 8'
- Heavy-duty 4.0mm thread knotted pillowcase style net
- Heavy-gauge 2" galvanized steel frame
- Heavy-duty wheel kit with no-flat turf protecting tires
- Heavy-duty fabric wrapped foam hip protector attaches with sewn Velcro strips

<b>BLPRO96</b>	Complete L-Screen	<b>\$665</b>
<b>BLPRO96N</b>	Replacement L-Screen Net	<b>\$170</b>
<b>BPROPAD</b>	Frame Padding Kit	<b>\$95</b>

### PROCAGE™ MINI PRO L-SCREEN

**Features:**

- Size: 7' x 5'
- Heavy-duty 4.0mm thread knotted pillowcase style net
- Heavy-gauge 2" galvanized steel frame
- Heavy-duty wheel kit with no-flat turf protecting tires
- Heavy-duty fabric wrapped foam encases entire frame

<b>BLPRO57</b>	Complete Mini L-Screen	<b>\$495</b>
<b>BLPRO57N</b>	Replacement Mini L-Screen Net	<b>\$135</b>

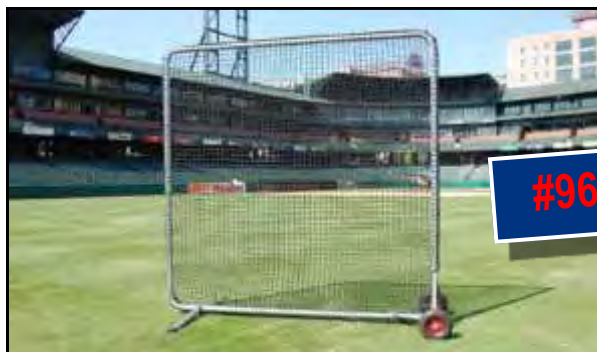

#96 NETTING

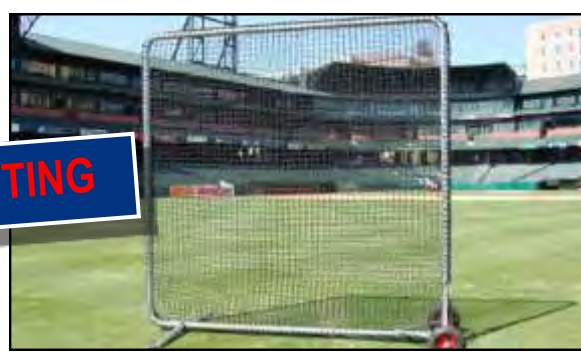

### PROCAGE™ “OLE 96er” FUNGO SCREEN

**Features:**

- Size: 8' x 8'
- Heavy-duty 4.0mm thread knotted pillowcase style net
- Heavy-gauge 2" galvanized steel frame
- Heavy-duty wheel kit with no-flat turf protecting tires

<b>BFPRO96</b>	Complete Fungo Screen	<b>\$680</b>
<b>BFPRO96N</b>	Replacement Fungo Net	<b>\$180</b>
<b>BPROPAD</b>	Frame Padding Kit	<b>\$95</b>

### PROCAGE™ PROFESSIONAL 10' x 10' SCREEN

**Features:**

- Size: 10' x 10'
- Heavy-duty 4.0mm thread knotted pillowcase style net
- Heavy-gauge 2" galvanized steel frame
- Heavy-duty wheel kit with no-flat turf protecting tires

<b>BFPRO10</b>	Complete Fungo Screen	<b>\$730</b>
<b>BFPRO10N</b>	Replacement Fungo Net	<b>\$205</b>
<b>BPROPAD</b>	Frame Padding Kit	<b>\$95</b>

**YOUR “ONE-STOP” SOURCE FOR AMERICA’S BASEBALL, SOFTBALL & SPORTS SURFACES & SUPPLIES!**

PRICES SUBJECT TO CHANGE & AVAILABILITY PLUS SHIPPING | VOLUME DISCOUNTS AVAILABLE | COOPERATIVE PURCHASING CONTRACT PRICING FOR 50 STATES

# BEAM CLAY®

ProCage Supreme Protective Screens

WHOLESALE PRICE LIST  
 EFFECTIVE: JULY 1, 2021



## ProCage™ Supreme Protective Screens



#60 NETTING



### PITCHER'S L-SCREEN PROTECTIVE SCREEN

**Features:**

- Size: 7' x 7' with 3.5' x 3.5' cutout
- Double 3.0mm knotted netting
- 1.5mm heavy wall steel tubing
- 1-1/2" round with hammer powder coat finish
- Push-button assembly
- Detachable legs for easy storage

<b>B607744</b>	Complete L-Screen	<b>\$290</b>
<b>B607744N</b>	Replacement L-Screen Net	<b>\$155</b>
<b>B77PAD</b>	Frame Padding Kit	<b>\$85</b>

### FIRST BASE/FUNGO PROTECTIVE SCREEN

**Features:**

- Size: 7' x 7'
- Double 3.0mm knotted netting
- 1.5mm heavy wall steel tubing
- 1-1/2" round with hammer powder coat finish
- Push-button assembly
- Detachable legs for easy storage

<b>B607720</b>	Complete First Base/Fungo Screen	<b>\$280</b>
<b>B607720N</b>	Replacement First Base/Fungo Net	<b>\$145</b>
<b>B77PAD</b>	Frame Padding Kit	<b>\$85</b>



### PROCAGE™ UNIVERSAL WHEEL KIT

Add this wheel kit to any round or square tube protective screen for additional mobility on and off the field! Fits up to 1-1/2" OD frames.

**Features:**

- Extra heavy-duty steel construction
- Large turf-type wheels
- Dual clamps for secure attachment
- Guaranteed to fit any protective screen with up to 1 1/2" diameter round or square tubing.

<b>BWHLKIT</b>	ProCage™ Universal Wheel Kit	<b>\$670</b>
----------------	------------------------------	--------------



### 9-HOLE PITCHING TARGET

**Features:**

- Constructed of a heavy-duty 2" steel frame with push-button assembly
- Heavy-duty knotless nylon netting with nine netting pockets
- Vinyl padding with yellow target zone sewn in the border
- Overall measurements 46"H x 36"W
- Target zone measuring 42"H x 36"W
- Ideal for evaluating pitcher accuracy

<b>BPTRAIN9</b>	9-Hole Pitch Trainer	<b>\$255</b>
<b>BPTRAIN9N</b>	Replacement Net	<b>\$120</b>

**YOUR "ONE-STOP" SOURCE FOR AMERICA'S BASEBALL, SOFTBALL & SPORTS SURFACES & SUPPLIES!**

PRICES SUBJECT TO CHANGE & AVAILABILITY PLUS SHIPPING | VOLUME DISCOUNTS AVAILABLE | COOPERATIVE PURCHASING CONTRACT PRICING FOR 50 STATES

# BEAM CLAY®

ProCage Premium Screens

WHOLESALE PRICE LIST  
EFFECTIVE: JULY 1, 2021



## ProCage™ Premium Screens



**PADDING SUGGESTED FOR SHORT-TOSS DRILLS**

### PITCHER'S L-SCREEN PROTECTIVE SCREEN

Protect your pitcher or pitching machine during batting practice.

**Features:**

- Size: 7' x 7' with 3.5" x 3.5" cutout
- Push-button assembly
- Detachable legs for storage
- Double 2.5mm #42 netting

<b>B427744</b>	Complete L-Screen	<b>\$220</b>
<b>B427744N</b>	Replacement L-Screen Net	<b>\$105</b>
<b>B77PAD</b>	Frame Padding Kit	<b>\$80</b>



### SOFTBALL PITCHER'S PROTECTIVE SCREEN

Protect your pitcher or pitching machine during batting practice.

**Features:**

- Size: 7' x 7' with 24" x 20" cutout
- Push-button assembly
- Detachable legs for storage
- Double 2.5mm #42 netting

<b>B427780</b>	Complete Softball Pitcher's Screen	<b>\$220</b>
<b>B427780N</b>	Replacement Softball Pitcher's Screen Net	<b>\$105</b>
<b>B77PAD</b>	Frame Padding Kit	<b>\$80</b>



### SOFTBALL PITCHER'S C-SCREEN PROTECTIVE SCREEN

**Features:**

- Size: 7' x 7' with 24" x 15" c-shaped cutout
- Push-button assembly
- Detachable legs for storage
- Double 2.5mm #42 netting

<b>B427790</b>	Complete Softball Pitcher's C-Screen	<b>\$220</b>
<b>B427790N</b>	Replacement C-Screen Net	<b>\$110</b>
<b>B77PAD</b>	Frame Padding Kit	<b>\$80</b>



### FIRST BASE/FUNGO PROTECTIVE SCREEN

Protect your players during intensive batting practice & fungo.

**Features:**

- Size: 7' x 7' with 3.5" x 3.5" cutout
- Push-button assembly
- Detachable legs for storage
- Double 2.5mm #42 netting

<b>B427720</b>	Complete First Base/Fungo Screen	<b>\$220</b>
<b>B427720N</b>	Replacement First Base/Fungo Net	<b>\$105</b>
<b>B77PAD</b>	Frame Padding Kit	<b>\$80</b>



### PROCAGE™ MINI FUNGO SCREEN

**Features:**

- Size: 7' x 4'
- Heavy-duty 2" square galvanized steel frame
- Swaged joints for easy assembly
- Detachable push-button legs for easy storage
- Heavy-duty pillowcase style 2.5mm #42 netting

**FRAME PADDING KIT RECOMMENDED!**

<b>BSQ4274</b>	Complete Mini Fungo Screen	<b>\$185</b>
<b>BSQ4274N</b>	Replacement Mini Fungo Net	<b>\$85</b>
<b>BSQ4274P</b>	Frame Padding Kit	<b>\$80</b>



### SOFT TOSS/SOCK NET PROTECTIVE SCREEN

**Features:**

- Size: 7' x 7' with 4' x 4" sock opening
- Push-button assembly
- Detachable legs for storage
- Double 2.5mm #42 netting

<b>B427700</b>	Complete Soft Toss/Sock Net Screen	<b>\$270</b>
<b>B427700N</b>	Replacement Soft Toss/Sock Net	<b>\$120</b>
<b>B77PAD</b>	Frame Padding Kit	<b>\$80</b>

**YOUR "ONE-STOP" SOURCE FOR AMERICA'S BASEBALL, SOFTBALL & SPORTS SURFACES & SUPPLIES!**

PRICES SUBJECT TO CHANGE & AVAILABILITY PLUS SHIPPING | VOLUME DISCOUNTS AVAILABLE | COOPERATIVE PURCHASING CONTRACT PRICING FOR 50 STATES

# BEAM CLAY®

**WHOLESALE PRICE LIST**  
 EFFECTIVE: JULY 1, 2021

## ProCage Black Series Protective Screens



# ProCage™ Black Series Protective Screens



**PITCHER'S L-SCREEN PROTECTIVE SCREEN**  
**Features:**  
 • Sturdy 18-gauge powder-coated 11/2" steel frame.  
 • Waterproof double-pillowcase netting.  
 • Push-button for easy assembly.  
 • Screen is retail packaged with UPC barcode.  
**Overall Size:**  
 Size: 7' x 7' with 3.5' x 3.5" cutout

<b>BSL77P</b>	Complete L-Screen	<b>\$155</b>
<b>B427744N</b>	Replacement L-Screen Net	<b>\$100</b>



**TRI-FOLD PROTECTIVE SCREEN**  
**Features:**  
 • Tri-fold Screen features a 1½" powder-coated steel frame.  
 • Waterproof pillowcase netting.  
 • Screen includes wheels and ground anchor stakes for added stability.  
**Overall Size:**  
 • 8'H x 16'W. (Main panel is 8'x8' with (2) 8'x4' wings).

<b>BTRIFLD</b>	Complete Tri-Fold Screen	<b>\$305</b>
<b>BTRINET</b>	Replacement Tri-Fold Net	<b>\$120</b>



**FIRST BASE/FUNGO PROTECTIVE SCREEN**  
**Features:**  
 • Sturdy 18-gauge powder-coated 11/2" steel frame.  
 • Waterproof double-pillowcase netting.  
 • Screen is retail packaged with UPC barcode.  
 • Size: 7' x 7' & 10' x 10'

<b>BSL77F</b>	Complete First Base/Fungo Screen	<b>\$155</b>
<b>B427720N</b>	Replacement First Base/Fungo Net	<b>\$100</b>
<b>BSL10F</b>	10' x 10' First Base/Fungo Screen	<b>\$220</b>
<b>BSL10FN</b>	Replacement First Base/Fungo Net	<b>\$120</b>



**SOFTBALL PITCHER'S PROTECTIVE SCREEN**  
 Protect your pitcher or pitching machine during batting practice.  
**Features:**  
 • Size: 7' x 7' with 24" x 20" cutout  
 • Push-button assembly  
 • Detachable legs for storage  
 • Double 2.5mm netting

<b>BSL77SB</b>	Complete Softball Pitcher's Screen	<b>\$155</b>
<b>B427780N</b>	Replacement Softball Pitcher's Screen Net	<b>\$100</b>



**SOFT TOSS/SOCK NET PROTECTIVE SCREEN**  
**Features:**  
 • Sturdy 18-gauge powder-coated 11/2" steel frame.  
 • Waterproof double-pillowcase netting.  
 • Screen is retail packaged with UPC barcode.  
 • Size: 7' x 7' with 4' x 4' sock opening.

<b>BSL77S</b>	Complete Soft Toss/Sock Net Screen	<b>\$185</b>
<b>B427700N</b>	Replacement Soft Toss/Sock Net	<b>\$100</b>

**YOUR "ONE-STOP" SOURCE FOR AMERICA'S BASEBALL, SOFTBALL & SPORTS SURFACES & SUPPLIES!**

PRICES SUBJECT TO CHANGE & AVAILABILITY PLUS SHIPPING | VOLUME DISCOUNTS AVAILABLE | COOPERATIVE PURCHASING CONTRACT PRICING FOR 50 STATES



# BEAM CLAY®

Protective Screens—JUGS

**BEAM CLAY OFFICE USE ONLY**  
EFFECTIVE: JULY 1, 2021

## PROTECTOR™ SERIES

### Protective Screens

**Your players are bigger and stronger today.  
Your protective screens should be too.**



JUGS Protector Series comes standard with the Protector Series Wheel Kit. Moving your screen has never been easier.

#### Recommended Skill Level

High Schools  
Colleges



#### Protector™ Series Replacement Netting:

<b>S6050</b>	L-Shaped	<b>\$310</b>
<b>S6065</b>	Softball	<b>\$310</b>
<b>S6060</b>	Square with Sock-Net™	<b>\$310</b>
<b>S6055</b>	Square Baseman	<b>\$310</b>
<b>S6070</b>	Short-Toss®	<b>\$275</b>



2-Year Guarantee on netting and frame against normal wear and factory defects—**No one guarantees their screens longer.**

## 5 hitting facility tough screens to choose from:



#### L-Shaped Screen

(7'H x 7'W), wheel kit included, double-thick 691-90 ply netting with hip protector.

**S6000** L-Shaped Screen **\$685**



#### C-Shaped Softball Screen

(7'H x 7'W, 33"H x 18"W cutout), wheel kit included, double-thick 691-90 ply netting

**S6016** C-Softball Screen **\$685**



#### Square Baseman Screen

(7'H x 7'W), wheel kit included, double-thick 691-90 ply netting

**S6005** Square Baseman Screen **\$685**



#### Square Screen with Sock-Net™

(7'H x 7'W), wheel kit included, double-thick 691-90 ply netting

**S6010** Square Screen with Sock-Net™ **\$685**



#### Short-Toss® Screen

(7'H x 4'W), wheel kit included, double-thick 691-90 ply netting

**S6020** Short-Toss® Screen **\$685**

**YOUR "ONE-STOP" SOURCE FOR AMERICA'S BASEBALL, SOFTBALL & SPORTS SURFACES & SUPPLIES!**

PRICES SUBJECT TO CHANGE & AVAILABILITY PLUS SHIPPING | VOLUME DISCOUNTS AVAILABLE | COOPERATIVE PURCHASING CONTRACT PRICING FOR 50 STATES

# BEAM CLAY®

Protective Screens—JUGS

WHOLESALE PRICE LIST  
 EFFECTIVE: JULY 1, 2021



These screens are designed specifically for close-range batting practice.

## PROTECTOR SERIES Protective Screens

### Features, Benefits & Facts:

- Black, pearl-foam, vinyl-covered 1/2"-thick padding
- Black, double-thick 691-90 ply, poly-E netting
- Screens are easily assembled—no welding or lacing.
- All joints are double-bolted for maximum strength and superior longevity.
- 1 1/2"-diameter, 2 mm-thick, 1020 cold-rolled steel frame tubing.



### Protector Series Wheel Kit:

- JUGS Protector Series Wheel Kit enables one person to easily move protector series screens by themselves.
- Quickly attaches to any JUGS Protector Series Screen.
- To engage wheel kit, simply lift screen directly above the wheel kit and kick the wheels under the screen—it's that simple.
- The perfect addition to our hitting facility tough Protector Series Screens.

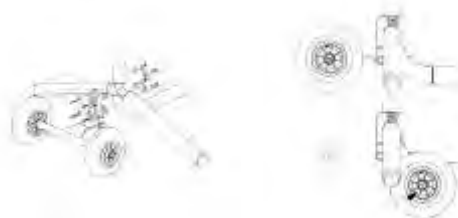

**A0720** Wheel Kit **\$170**



**YOUR "ONE-STOP" SOURCE FOR AMERICA'S BASEBALL, SOFTBALL & SPORTS SURFACES & SUPPLIES!**

PRICES SUBJECT TO CHANGE & AVAILABILITY PLUS SHIPPING | VOLUME DISCOUNTS AVAILABLE | COOPERATIVE PURCHASING CONTRACT PRICING FOR 50 STATES

**PARTAC PEAT CORPORATION**  
 ONE KELSEY PARK, GREAT MEADOWS, NEW JERSEY 07838

800-247-BEAM (2326) • (908) 637-4191 • FAX (908) 637-8421  
 www.beamclay.com • sales@beamclay.com  
 Bid Term - 5/9/18 - 5/8/20; Extended to 5/8/21; Extended to 5/8/22

# BEAM CLAY®

Protective Screens—JUGS

WHOLESALE PRICE LIST  
EFFECTIVE: JANUARY 1, 2021



## BACKYARD BULLPEN®

Package for baseball or softball

Helping baseball and softball players of all ages become pitchers, not just throwers.

1. BACKYARD BULLPEN® Screen—a huge 7' portable screen with 12 Hit-Your-Spot™ pockets.
2. JUGS Radar Cube™ and tripod. The JUGS Radar Cube™ shares the same accuracy index as the world famous JUGS Radar Gun: +1/2 mph.
3. (15) Perfect Pitch™ Throwing Balls. Leather baseballs or softballs with pitch count and location on each ball.
4. Heavy-Duty Nylon Carrying Bag
5. Throw-Down Home Plate

<b>R2115</b>	Backyard Bullpen™ Package-Baseball	<b>\$800</b>
<b>R2120</b>	Backyard Bullpen™ Package-Softball	<b>\$800</b>
<b>S0400</b>	Backyard Bullpen™ Screen ONLY	<b>\$325</b>

### Recommended Skill Level

- Backyard & Youth League Players
- High Schools

The key to pitching is Speed and Location.

12 individual Hit-Your-Spot™ pockets isolate specific spots in the strike zone, and out. This will help pitchers work on their accuracy.

For the beginning pitcher, or for those more advanced.

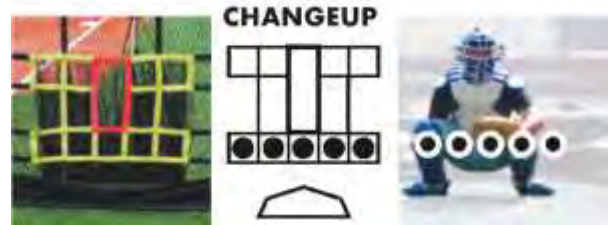

### Perfect Pitch™ throwing balls are the key!

Becoming a great pitcher is the ability to recognize the relationship between “the count” and ball location, then mastering the execution of that pitch. PERFECT PITCH™ leather baseballs and softballs teach this very thing.



**YOUR “ONE-STOP” SOURCE FOR AMERICA’S BASEBALL, SOFTBALL & SPORTS SURFACES & SUPPLIES!**

PRICES SUBJECT TO CHANGE & AVAILABILITY PLUS SHIPPING | VOLUME DISCOUNTS AVAILABLE | COOPERATIVE PURCHASING CONTRACT PRICING FOR 50 STATES

**PARTAC PEAT CORPORATION**  
ONE KELSEY PARK, GREAT MEADOWS, NEW JERSEY 07838

800-247-BEAM (2326) • (908) 637-4191 • FAX (908) 637-8421  
www.beamclay.com • sales@beamclay.com  
Bid Term - 5/9/18 - 5/8/20; Extended to 5/8/21; Extended to 5/8/22

# BEAM CLAY®

Pepper Rebound Screen

**WHOLESALE PRICE LIST**  
 EFFECTIVE: JULY 1, 2021



**INVERT SCREEN TO PRACTICE GROUND BALLS**

**FLIP SCREEN TO RETURN POP-FLYS**



PEPPER REBOUND SCREEN		
Improves reflexes by randomly rebounding balls at the player Easily adjusts to return ground balls, line-drives and pop-flys Powder-coated 1 1/4" steel tube frame Weatherized, high visibility 30 ply PE net with 1 3/4" mesh Push-pin connections and included net tension tool makes for easy set-up		
<b>NB51</b>	<b>72" W X 42" H</b>	<b>\$67.95/EA</b>



### FOUR DIFFERENT REBOUND POSITIONS!

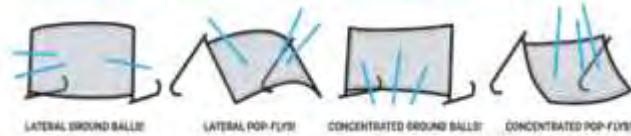

**SEBALL, SOFTBALL & SPORTS SURFACES & SUPPLIES!**

PRICES SUBJECT TO CHANGE & AVAILABILITY PLUS SHIPPING | VOLUME DISCOUNTS AVAILABLE | COOPERATIVE PURCHASING CONTRACT PRICING FOR 50 STATES

**PARTAC PEAT CORPORATION**  
 ONE KELSEY PARK, GREAT MEADOWS, NEW JERSEY 07838

800-247-BEAM (2326) • (908) 637-4191 • FAX (908) 637-8421  
 www.beamclay.com • sales@beamclay.com  
 Bid Term - 5/9/18 - 5/8/20; Extended to 5/8/21; Extended to 5/8/22

# BEAM CLAY®

Baseball Rebound Screen

**WHOLESALE PRICE LIST**  
EFFECTIVE: JULY 1, 2021

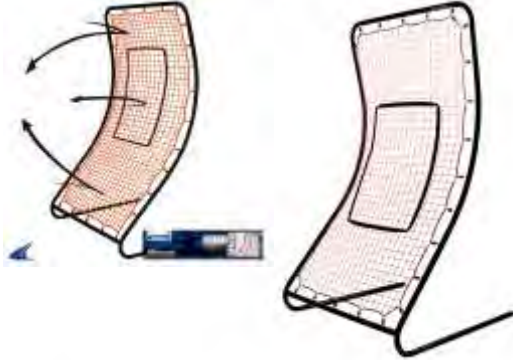

INFINITY REBOUND SCREEN		
Unique frame design provides infinite rebound angles without adjustment Consistent practice improves reaction times and builds muscle memory Powder-coated 1 1/4" steel tube frame Weatherized, high visibility 30 ply PE net with 1 3/4" mesh Push-pin connections and included net tension tool makes for easy set-up		
<b>NB26</b>	72" X 42" 1 1/4" STEEL TUBE FRAME	\$58.95/EA
<b>NB28</b>	54" X 36" 1" STEEL TUBE FRAME	\$43.95/EA
<b>NB26E</b>	72" X 42" BULK PACKAGED	\$46.95/EA



VIRTUAL CATCHER/REBOUNDER		
Baseball catcher and rebound screen on one frame Mesh bag collects balls Easy pushpin assembly		
<b>NB25</b>	52" X 36"	\$55.95/EA
<b>NBBH</b>	REPLACEMENT BUNGEE HOOKS - 10 PACK	\$7.95/EA

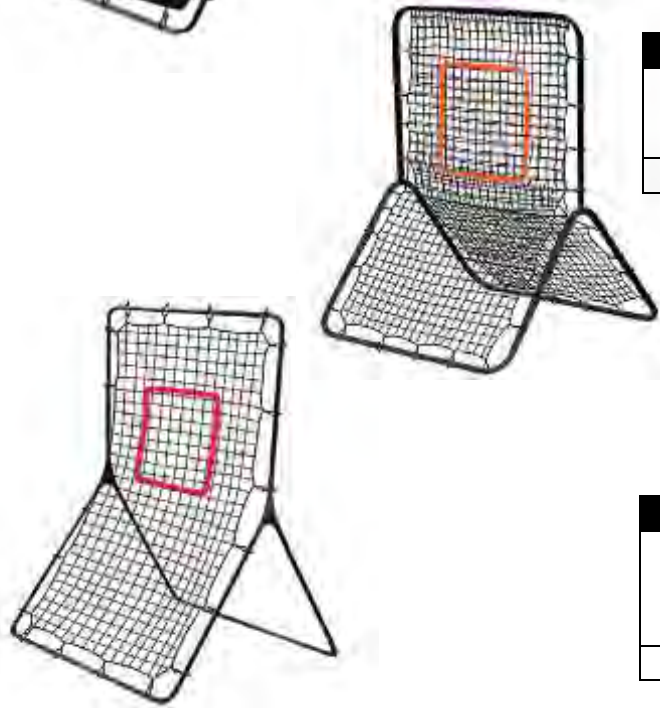

PITCHBACK		
Powder coated steel tube frame Weatherized 30 ply PE net with 1 3/4" mesh Strike zone outline included		
<b>NB10</b>	58" X 42"	\$53.95/EA

REBOUND SCREEN		
Returns baseballs & softballs as ground balls, line drives or pop-flys Durable 1" steel tube construction Weatherized PE net Push-pin connections make for easy set-up		
<b>NB24</b>	52" X 36"	\$34.95/EA

**YOUR "ONE-STOP" SOURCE FOR AMERICA'S BASEBALL, SOFTBALL & SPORTS SURFACES & SUPPLIES!**

PRICES SUBJECT TO CHANGE & AVAILABILITY PLUS SHIPPING | VOLUME DISCOUNTS AVAILABLE | COOPERATIVE PURCHASING CONTRACT PRICING FOR 50 STATES

# BEAM CLAY®

**WHOLESALE PRICE LIST**  
 EFFECTIVE: JULY 1, 2021

## Brute Screens for Batting Cages



# BRUTE SCREENS

## FOR BATTING CAGES

Dent Resistant 13.5 Gauge Heavy-Duty Steel Tubing  
 All-Weather Coating  
 3-Year Frame Warranty



Extra-Strength 60-Ply PE. Net  
 1-Year Net Warranty



### BRUTE INFIELD SCREEN

7' x 7' screen can be used during drills or as a portable backstop  
 Durable 1.5", 13.5 gauge steel tube frame  
 Extra strength 60-ply, envelope style PE net  
 Easy pushpin assembly

<b>NB185</b>	7' X 7'	\$209.95/EA
<b>NB185RS</b>	7' X 7' REPLACEMENT SCREEN	\$104.95/EA



### BRUTE SOCK SCREEN

Screen with 54" sock for collecting batted/thrown balls  
 Sock opens to dump balls into bucket or ball bag  
 Durable 1.5", 13.5 gauge steel tube frame  
 Extra-strength 60-ply, envelope style PE net  
 Easy pushpin assembly

<b>NB187</b>	7' X 7'	\$223.95/EA
<b>NB187RS</b>	7' X 7' REPLACEMENT SCREEN	\$104.95/EA



### BRUTE PITCHER'S SAFETY SCREEN

Reversible "L" shape for right or left handed pitchers  
 Durable 1.5", 13.5 gauge steel tube frame  
 Extra strength 60-ply, envelope style PE net  
 Easy pushpin assembly

<b>NB183</b>	7' X 7'	\$209.95/EA
<b>NB183RS</b>	7' X 7' REPLACEMENT SCREEN	\$104.95/EA



### BRUTE "Z" SCREEN

Unique shape allows pitchers to stay protected throwing over or underhand during batting practice  
 Reversible design for right and left hand pitchers  
 Durable 1.5", 13.5 gauge steel tube frame  
 Extra strength 60-ply, envelope style PE net  
 Easy push pin assembly

<b>NBZ</b>	7' X 5'	\$181.95/EA
<b>NBZRS</b>	7' x 5' REPLACEMENT SCREEN	\$90.95/EA

**YOUR "ONE-STOP" SOURCE FOR AMERICA'S BASEBALL, SOFTBALL & SPORTS SURFACES & SUPPLIES!**

PRICES SUBJECT TO CHANGE & AVAILABILITY PLUS SHIPPING | VOLUME DISCOUNTS AVAILABLE | COOPERATIVE PURCHASING CONTRACT PRICING FOR 50 STATES

# BEAM CLAY®

Champro Multi-Sport Screens

## WHOLESALE PRICE LIST



### MVP DURABILITY

Heavy-duty screens for all levels



### QUICK SET-UP

Assembles in less than two minutes!

### TRAIN ANYWHERE

Includes carry bag for easy transport



**YOUR "ONE-STOP" SOURCE FOR AMERICA'S BASEBALL, SOFTBALL & SPORTS SURFACES & SUPPLIES!**

PRICES SUBJECT TO CHANGE & AVAILABILITY PLUS SHIPPING | VOLUME DISCOUNTS AVAILABLE | COOPERATIVE PURCHASING CONTRACT PRICING FOR 50 STATES

**PARTAC PEAT CORPORATION**  
ONE KELSEY PARK, GREAT MEADOWS, NEW JERSEY 07838

800-247-BEAM (2326) • (908) 637-4191 • FAX (908) 637-8421  
www.beamclay.com • sales@beamclay.com  
Bid Term - 5/9/18 - 5/8/20; Extended to 5/8/21; Extended to 5/8/22

# BEAM CLAY®

Champro Multi-Sport Screens

**WHOLESALE PRICE LIST**  
 EFFECTIVE: JULY 1, 2021

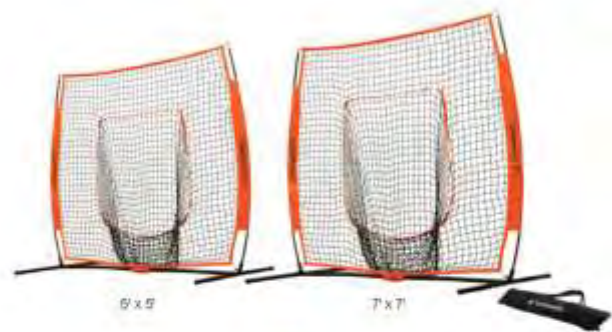

MVP PORTABLE TRAINING SCREEN		
Shock-absorbent fiberglass poles withstand elite training Oversized sock-style net gathers balls for easy pickup Includes TZ3 training zone for accuracy drills High-visibility orange frame with mesh netting Easy-to-assemble metal frame with pushpin connections Includes carry bag and stakes		
<b>NB32</b>	5' x 5'	\$67.95/EA
<b>NB32R</b>	5' x 5' REPLACEMENT TZ3 TARGET	\$6.95/EA
<b>NB35</b>	7' X 7'	\$76.95/EA
<b>NB35R</b>	7' X 7' REPLACEMENT TZ3 TARGET	\$6.95/EA

MVP PORTABLE SOCK SCREEN		
Shock-absorbent fiberglass poles withstand elite training 3'x3' sock opening gathers balls for easy pickup High-visibility orange frame with mesh netting Easy-to-assemble metal frame with pushpin connections Includes carry bag and stakes		
<b>NB43</b>	5' x 5'	\$67.95/EA
<b>NB44</b>	7' X 7'	\$76.95/EA
<b>NB44E</b>	7' X 7' BULK PACKAGED	\$69.95/EA

MVP PORTABLE L SCREEN		
Constructed of shock-absorbent fiberglass poles Heavy gauge netting is ideal for youth baseball/softball practice High-visibility orange frame with mesh netting Easy-to-assemble metal frame with pushpin connections Includes carry bag and stakes		
<b>NB42</b>	7' X 7'	\$76.95/EA

MVP SOFTBALL PITCHER'S SCREEN		
Shock-absorbent fiberglass poles withstand elite training Mesh net with pitching window for softball players or pitching machines High-visibility orange frame with mesh netting Easy-to-assemble metal frame with pushpin connections Includes carry bag for easy transport		
<b>NB52</b>	7' X 7'	\$69.95/EA

MVP PORTABLE BARRIER		
Fiberglass poles withstand elite training Oversized 20' x 8' screen stops passed balls High-visibility orange frame with mesh netting Easy-to-assemble metal frame with pushpin connections Includes carry bag and stakes Requires two people for assembly		
<b>NLB</b>		\$103.95/EA

**YOUR "ONE-STOP" SOURCE FOR AMERICA'S BASEBALL, SOFTBALL & SPORTS SURFACES & SUPPLIES!**

PRICES SUBJECT TO CHANGE & AVAILABILITY PLUS SHIPPING | VOLUME DISCOUNTS AVAILABLE | COOPERATIVE PURCHASING CONTRACT PRICING FOR 50 STATES



# Practice Balls

**LeatherLast™**



**Pearl®**



**Realistic-Seam Baseballs**



**Pearl®**



**LeatherLast™**



**Realistic-Seam Softballs**



**Dimpled**



**Bulldog™**



**Lite-Flite®**



**YOUR "ONE-STOP" SOURCE FOR AMERICA'S BASEBALL, SOFTBALL & SPORTS SURFACES & SUPPLIES!**

PRICES SUBJECT TO CHANGE & AVAILABILITY PLUS SHIPPING | VOLUME DISCOUNTS AVAILABLE | COOPERATIVE PURCHASING CONTRACT PRICING FOR 50 STATES

**BEAM CLAY®****JUG Practice and Game Balls****WHOLESALE PRICE LIST**  
EFFECTIVE: JULY 1, 2021

# Practice Balls

Perfect Pitch™ Baseballs (15)	<b>B5300</b>	<b>\$80.95/PACK</b>
Perfect Pitch™ Softballs (15)	<b>B5310</b>	<b>\$103.95/PACK</b>
Sting-Free® Baseballs, realistic seam White	<b>B3000</b>	<b>\$61.95/DOZ</b>
Sting-Free® Baseballs, dimpled-style—White	<b>B1005</b>	<b>\$61.95/DOZ</b>
Sting-Free® Baseballs, dimpled-style—Optic Yellow	<b>B1000</b>	<b>\$61.95/DOZ</b>
Sting-Free® Softballs Optic Game-Ball Yellow™ Dimpled	<b>B2015</b>	<b>\$72.95/DOZ</b>
Sting-Free® Softballs Optic Game-Ball Yellow™ Seamed	<b>B4015</b>	<b>\$72.95/DOZ</b>
11" Sting-Free® Softballs, dimpled-style Optic Game-Ball Yellow™ Dimpled	<b>B2020</b>	<b>\$72.95/DOZ</b>
JUGS Pearl® Leather Baseballs	<b>B5200</b>	<b>\$113.95/DOZ</b>
NEW JUGS LeatherLast™ Leather Softballs	<b>B5250</b>	<b>\$146.95/DOZ</b>
Lite-Flite® Baseballs Optic Yellow	<b>B5000</b>	<b>\$50.95/DOZ</b>
Lite-Flite® Softballs 12" Optic Game-Ball Yellow™	<b>B5005</b>	<b>\$61.95/DOZ</b>
Lite-Flite® Softballs 11" Optic Game-Ball Yellow™	<b>B5010</b>	<b>\$61.95/DOZ</b>
Softie® Genuine Leather Practice Baseballs White	<b>B5100</b>	<b>\$106.95/DOZ</b>
Softie® Genuine Leather Practice Softballs 12" Optic Game-Ball Yellow™	<b>B5105</b>	<b>\$124.95/DOZ</b>
Softie® Genuine Leather Practice Softballs 11" Optic Game-Ball Yellow™	<b>B5110</b>	<b>\$124.95/DOZ</b>
JUGS BULLDOG™ Polyball Baseballs White	<b>B6005</b>	<b>\$27.95/DOZ</b>
JUGS BULLDOG™ Polyball Baseballs Vision-Enhanced Yellow™	<b>B6010</b>	<b>\$27.95/DOZ</b>
JUGS BULLDOG™ Polyball Baseballs Bulk Box—100 Individual Balls—White	<b>B6006</b>	<b>\$172.95/BB</b>
JUGS BULLDOG™ Polyball Baseballs Vision-Enhanced Yellow™	<b>B6011</b>	<b>\$172.95/BB</b>
JUGS BULLDOG™ Polyball Softballs Game-Ball Yellow™	<b>B7010</b>	<b>\$38.95/DOZ</b>
JUGS BULLDOG™ Polyball Softballs Bulk Box—84 Individual Balls—Game-Ball Yellow™	<b>B7011</b>	<b>\$206.95/BB</b>
Small-Ball® White	<b>B5130</b>	<b>\$23.95/DOZ</b>
Small-Ball® Vision-Enhanced Yellow™	<b>B5132</b>	<b>\$23.95/DOZ</b>
Small-Ball® 25 DOZEN OR MORE White or Vision-Enhanced Yellow™	<b>B5130A</b>	<b>\$21.95/DOZ</b>
JUGS Lacrosse Balls White	<b>B1100</b>	<b>\$61.95/DOZ</b>
JUGS Lacrosse Balls Yellow	<b>B1105</b>	<b>\$61.95/DOZ</b>

**BUCKET OF BALLS**

Bucket of JUGS Pearl® Baseballs—4-Dozen Balls (Includes FREE Pujols Bucket with Lid)	<b>B5210</b>	<b>\$456/Bucket</b>
NEW Bucket of JUGS LeatherLast™ Softballs—2-Dozen Balls (Includes FREE Michele Smith Bucket with Lid)	<b>B5260</b>	<b>\$291/Bucket</b>
Bucket of JUGS BULLDOG™ Baseballs—18 Balls Vision-Enhanced Yellow™	<b>B6012</b>	<b>\$57/Bucket</b>
Bucket of JUGS BULLDOG™ Baseballs—18 Balls White	<b>B6007</b>	<b>\$57/Bucket</b>
Bucket of JUGS BULLDOG™ Softballs—12 Balls Game-Ball Yellow™	<b>B7012</b>	<b>\$57/Bucket</b>
Bucket of Lite-Flite® Baseballs—18 Balls Optic Yellow	<b>B5001</b>	<b>\$84.95/Bucket</b>
Bucket of Lite-Flite® Softballs—12 Balls Optic Game-Ball Yellow™	<b>B5006</b>	<b>\$84.95/Bucket</b>
Bucket of JUGS Small-Ball®—4-Dozen Balls White	<b>B5135</b>	<b>\$79.95/Bucket</b>
Bucket of JUGS Small-Ball®—4-Dozen Balls Vision-Enhanced Yellow™	<b>B5140</b>	<b>\$79.95/Bucket</b>

**YOUR "ONE-STOP" SOURCE FOR AMERICA'S BASEBALL, SOFTBALL & SPORTS SURFACES & SUPPLIES!**

PRICES SUBJECT TO CHANGE &amp; AVAILABILITY PLUS SHIPPING | VOLUME DISCOUNTS AVAILABLE | COOPERATIVE PURCHASING CONTRACT PRICING FOR 50 STATES

**PARTAC PEAT CORPORATION**  
ONE KELSEY PARK, GREAT MEADOWS, NEW JERSEY 07838**800-247-BEAM (2326) • (908) 637-4191 • FAX (908) 637-8421**  
**www.beamclay.com • sales@beamclay.com**  
Bid Term - 5/9/18 - 5/8/20; Extended to 5/8/21; Extended to 5/8/22

# BEAM CLAY®

## Champro Batting Tees

**WHOLESALE PRICE LIST**  
EFFECTIVE: JANUARY 1, 2021



BRUTE BATTING TEE		
Built for elite hitters Flexible top reduces swing resistance Weighted base with non-slip rubber feet Locking clamps for easy height adjustment from 27" to 47" Includes two year warranty Retail packaged		
<b>B080</b>	BRUTE BATTING TEE	\$47.95/EA
<b>B070R</b>	REPLACEMENT RUBBER TOP	\$4.95/EA



LOCKING CLAMPS EASILY CONTROL HEIGHT FOR ALL AGES



RUBBER FOOTING MAXIMIZES GRIP ON ALL SURFACES

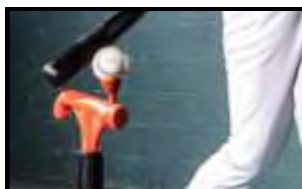

PROMOTES A DOWNWARD SWING PATH



PROVIDES IMMEDIATE FEEDBACK FOR IMPROPER SWINGS

EQUITEE® BATTING TEE		
Designed by a Major League player to improve your swing Consistent training develops a swing that produces consistent, solid contact to create line drives Reinforced rubber tubes built to withstand elite level training Telescoping tubes adjust height from 22" to 37" Thick, weighted base keeps tee upright during training Retail packaged		
<b>B060</b>	EQUITEE BATTING TEE	\$78.95/EA
<b>B061</b>	REPLACEMENT BALL HOLDERS - 2 PACK	\$8.95/PK



TUBES SNAP ONTO PLATE FOR EASY TRANSPORT



HEAVY-DUTY 5-POSITION TEE		
The toughest rubber tee, designed for extreme durability Oversized, heavy-duty rubber plate with 5 hitting positions Reinforced rubber tubes built to withstand elite level training Telescoping tubes adjust height from 21" to 36" Tubes snap onto plate for easy transport Retail packaged		
<b>B064</b>	HEAVY-DUTY 5-POSITION TEE	\$37.95/EA

**YOUR "ONE-STOP" SOURCE FOR AMERICA'S BASEBALL, SOFTBALL & SPORTS SURFACES & SUPPLIES!**

PRICES SUBJECT TO CHANGE & AVAILABILITY PLUS SHIPPING | VOLUME DISCOUNTS AVAILABLE | COOPERATIVE PURCHASING CONTRACT PRICING FOR 50 STATES

# BEAM CLAY®

CHAMPRO Batting Tees

**WHOLESALE PRICE LIST**  
EFFECTIVE: JULY 1, 2021



### ULTIMATE 3-IN-1 BATTING TEE

Consistent practice with the Ultimate Tee will help you generate a line drive swing, make better ball contact, reduce the number of pop-ups, and improve your batting average  
Brush top reduces swing resistance  
Height adjusts from 21" to 34"

<b>B069</b>	ULTIMATE 3-IN-1 BATTING TEE	<b>\$37.95/EA</b>
<b>B069R</b>	REPLACEMENT BALL HOLDERS - 2 PACK	<b>\$9.95/EA</b>



DUAL-ENDED BRUSH TUBE FEATURES BRUSH AND TRADITIONAL TOPS



5-POSITION BASE COVERS ALL CORNERS OF THE PLATE



TUBES SNAP ONTO PLATE FOR EASY TRANSPORT



### 5-POSITION TEE

Train for every pitch with 5 hitting positions  
Heavy-duty, official size rubber plate  
Telescoping tubes adjust height from 21" to 36"  
Tubes snap onto plate for easy transport  
Retail packaged

<b>B063</b>	5-POSITION TEE	<b>\$25.95/EA</b>
-------------	----------------	-------------------



TUBES SNAP ONTO PLATE FOR EASY TRANSPORT



### 3-POSITION TEE

Rubber plate with 3 hitting positions  
Adjustable PE tubes with pushpin adjustment  
Flexible rubber top  
Tubes snap onto plate for easy transport  
Retail packaged

<b>B062</b>	3-POSITION TEE	<b>\$19.95/EA</b>
-------------	----------------	-------------------

**YOUR "ONE-STOP" SOURCE FOR AMERICA'S BASEBALL, SOFTBALL & SPORTS SURFACES & SUPPLIES!**

PRICES SUBJECT TO CHANGE & AVAILABILITY PLUS SHIPPING | VOLUME DISCOUNTS AVAILABLE | COOPERATIVE PURCHASING CONTRACT PRICING FOR 50 STATES

# BEAM CLAY®

## WHOLESALE PRICE LIST EFFECTIVE: JULY 1, 2021

### CHAMPRO Batting Tees



MVP RUBBER BATTING TEE		
Pro-style base made from heavy-duty rubber Ultra-flexible rubber top reduces swing resistance Height adjusts from 25" to 40" Bottom tube features metal insert for increased durability Weighted square base with waffle bottom for increased traction Can be used as a traditional tee without flexible cone top		
<b>B101</b>	MVP RUBBER BATTING TEE	<b>\$22.95/EA</b>



HEAVY-DUTY RUBBER BATTING TEE		
Official size home plate Heavy-duty telescoping rubber tubes adjust from 21" to 36"		
<b>B050I</b>	HEAVY-DUTY RUBBER BATTING TEE	<b>\$18.95/EA</b>
<b>B054</b>	TOP RUBBER REPLEMENT TUBE	<b>\$6.95/EA</b>



PRO-GRADE FOLDING BATTING TEE		
Durable, pro-grade materials for elite training Flexible top reduces swing resistance Wide base prevents tipping during training Compact design fits into a standard bat bag Height adjusts from 30" to 45" Retail packaged		
<b>B070</b>	PRO-GRADE FOLDING BATTING TEE	<b>\$22.95/EA</b>
<b>B070R</b>	REPLACEMENT RUBBER TOP	<b>\$4.95/EA</b>



FOLDS TO THE SIZE OF A STANDARD BAT TO FIT IN BAG

PORTABLE LIGHTWEIGHT BATTING TEE		
Flexible top works with baseballs and softballs Weighted, foldable quadpod base Tee quickly folds to fit inside a standard bat bag Height adjusts from 24" to 36" Retail packaged		
<b>B066</b>	PORTABLE LIGHTWEIGHT BATTING TEE	<b>\$21.95/EA</b>



HIGH IMPACT TEE		
Perfect batting tee for new baseball/softball players Official molded rubber plate Durable cupped rubber tee Easy to assemble		
<b>B051</b>	HIGH IMPACT TEE ONLY	<b>\$13.95/EA</b>



BRUSH TOP TEE ADAPTER		
Reduces swing resistance and wear & tear on bats Ideal for all levels of baseball and softball Easy to install, fits most batting tees		
<b>B068-AD</b>	BRUSH TOP TEE ADAPTER	<b>\$6.95/EA</b>

**YOUR "ONE-STOP" SOURCE FOR AMERICA'S BASEBALL, SOFTBALL & SPORTS SURFACES & SUPPLIES!**

PRICES SUBJECT TO CHANGE & AVAILABILITY PLUS SHIPPING | VOLUME DISCOUNTS AVAILABLE | COOPERATIVE PURCHASING CONTRACT PRICING FOR 50 STATES

# BEAM CLAY®

## JUGS Batting Tees

**WHOLESALE PRICE LIST**  
EFFECTIVE: JULY 1, 2021



- Recommended Skill Level
- Backyard Players
  - Youth Leagues
  - High Schools and Colleges
  - Professionals



## JUGS® T

**A hitting tee is the most commonly used training tool for baseball and softball. Shouldn't you practice with the best?**

**Features, Benefits & Facts:**

- Longest guarantee and lowest price for a tee of this quality.
- Large 14"x 11", 1/4"-thick steel base adds stability. Weighs less than 10 lbs.
- No outside weight needed. Will not tip over.
- Telescoping stem unscrews from base.
- Quick adjustment range of 24" to 46" allows hitters to work on their swing mechanics throughout the strike zone.
- Great for high- and low-tee drills.
- Always-feel-the-ball flexible top. Feel the ball on contact, not the tee.
- Unlike similar designed tees, our patented internal interlocking bolt design prevents slippage of the upper tee stem.
- Base comes complete with patented grip-n-go™ handle. Makes for easy transport and will fit into most travel bags.

<b>A0415</b>	<b>JUGS® T</b>	<b>\$108.95/EA</b>
--------------	----------------	--------------------



- Recommended Skill Level
- Backyard Players
  - Youth Leagues
  - High Schools and Colleges
  - Professionals



## JUGS® Short T

**Learn to hit the "pitcher's pitch".**

- Longest guarantee and lowest price for a tee of this quality.
- Large 14"x 11", 1/4"-thick steel base adds stability. Weighs less than 10 lbs.
- No outside weight needed. Will not tip over.
- Quick adjustment range of 16" to 23" allows hitters to work on the pitch at the bottom of the strike zone.
- Always-feel-the-ball flexible top. Feel the ball on contact, not the tee.
- Unlike similar designed tees, our patented internal interlocking bolt design prevents slippage of the upper tee stem.
- Base comes complete with patented grip-n-go™ handle. Makes for easy transport and will fit into most travel bags.

<b>A0416</b>	<b>JUGS® Short T</b>	<b>\$96.95/EA</b>
--------------	----------------------	-------------------



## Combo T Package

**For complete plate coverage, purchase 2 stems and 1 base.**

- This package includes:
- Regular JUGS T stem: 24" – 46"
  - NEW SHORT T stem: 16" – 23"
  - One T base.

<b>A0417</b>	<b>Combo T Package</b>	<b>\$159.95/EA</b>
--------------	------------------------	--------------------

**YOUR "ONE-STOP" SOURCE FOR AMERICA'S BASEBALL, SOFTBALL & SPORTS SURFACES & SUPPLIES!**

PRICES SUBJECT TO CHANGE & AVAILABILITY PLUS SHIPPING | VOLUME DISCOUNTS AVAILABLE | COOPERATIVE PURCHASING CONTRACT PRICING FOR 50 STATES

# BEAM CLAY®

## JUGS Batting Tees

**WHOLESALE PRICE LIST**  
EFFECTIVE: JULY 1, 2021



Recommended Skill Level  
• Backyard Players  
• Youth Leagues

**A hitting tee is the most commonly used training tool for baseball and softball.**

### Hit Like a Pro Hitting Tee™

**Features, Benefits & Facts:**

2D Barcode located on base of tee links to video, highlighting the proper way to use the tee for both right- and left-handed hitters and a number of tee drills as well.  
Ribbed upper tee tube will prevent your tee tube from slipping during practice.  
Durable solid-rubber base.  
Disassembles for easy storage.  
Fully adjustable extension tube.  
Patented Grip-n-Go™ handle for easy transport.

<b>A0400</b>	<b>Hit Like a Pro Hitting Tee™</b>	<b>\$37/EA</b>
--------------	------------------------------------	----------------



**HIT THE BALL WHERE IT'S PITCHED!**



Recommended Skill Level  
• Backyard and Youth League Players  
• High Schools and Colleges  
• Professionals

### 5-Point Hitting Tee™

**Features, Benefits & Facts:**

2D Barcode located on base of tee links to video drills highlighting the proper way to use the tee along with challenging drills for the advanced player.  
Teaches correct contact points for inside, middle, and outside pitches.  
Develops hand-eye coordination and a quick bat.  
Teaches the hitter to use the whole field.  
Ribbed upper tee tubes will prevent your tee tubes from slipping during practice.  
Patented crisscross 5-point design.  
Patented Grip-n-Go™ handle for easy transport  
Patented ball rest is designed for stable placement for both baseballs and softballs.

<b>A0410</b>	<b>5-Point Hitting Tee™</b>	<b>\$103/EA</b>
--------------	-----------------------------	-----------------



**YOUR "ONE-STOP" SOURCE FOR AMERICA'S BASEBALL, SOFTBALL & SPORTS SURFACES & SUPPLIES!**

PRICES SUBJECT TO CHANGE & AVAILABILITY PLUS SHIPPING | VOLUME DISCOUNTS AVAILABLE | COOPERATIVE PURCHASING CONTRACT PRICING FOR 50 STATES

# BEAM CLAY®

**WHOLESALE PRICE LIST**  
 EFFECTIVE: JANUARY 1, 2021

Batting Practice - Synthetic Turf for Batting Tunnels

## SYNTHETIC TURF FOR BASEBALL & SOFTBALL

Ideal for batting tunnels, dugouts, bullpens, walkways, coaching boxes and locker rooms. 100% polypropylene, with 1mm rubber backing (for a firmer feel, especially for loose lay applications), 5mm foam-rubber backing (for a softer cushion), SilverBack™ polyurethane backing. Can be installed outdoors or indoors on a compacted aggregate base or on concrete. Comes in 12' or 15' wide rolls. 10' minimum order length.

### TURF BY THE ROLL

<b>357245F12</b>	24 oz. polypropylene pile, 12' wide, pine green, 5mm foam	<b>\$3.25/SF</b>
<b>357245F1255</b>	12' W x 55' L Roll	<b>\$2,145/roll</b>
<b>357245F1270</b>	12' W x 70' L Roll	<b>\$2,730/roll</b>
<b>357243F12</b>	24 oz. polypropylene pile, 12' wide, pine green, 3mm foam	<b>\$2.85/SF</b>
<b>357243F1255</b>	12' W x 55' L Roll	<b>\$1,881/roll</b>
<b>357243F1270</b>	12' W x 70' L Roll	<b>\$2,394/roll</b>
<b>35724SB12</b>	24 oz. polypropylene pile, 12' wide, pine green, SilverBack™ polyurethane	<b>\$2.10/SF</b>
<b>35724SB1255</b>	12' W x 55' L Roll	<b>\$1,386/roll</b>
<b>35724SB1270</b>	12' W x 70' L Roll	<b>\$1,764/roll</b>
<b>177363F15</b>	36 oz. polyethylene/polypropylene blend 15' wide, field/lime green, 3 mm foam	<b>\$2.85/SF</b>
<b>177363F1555</b>	15' W x 55' L Roll	<b>\$2,351.25/roll</b>
<b>177363F1570</b>	15' W x 70' L Roll	<b>\$2,992.50/roll</b>

Blending polyethylene and polypropylene gives excellent durability and wear resistance. An ideal choice for batting tunnels and indoor facilities over concrete. Use of stance mats recommended for batting tunnels.

**PLEASE NOTE:** Synthetic Turf is normally rolled face out. No charge to "reverse roll" cut pieces with turf faced in—which makes it easier to install—doesn't need to be flipped over.

There is a charge per piece to cut the width (there is a 1/4" tolerance) and/or pre-trim the scrim fabric along edge and reverse roll so that each piece will unroll with turf side up. For full rolls, there is a charge for pre-trimming & reverse rolling.

If gluing to concrete, use Robert's 6700 glue from Home Depot if 65° or warmer, Turf Claw™ if 55°+, or Nordot 34-G if 50°+. If installing over compacted aggregate, you need to spike perimeter and tape (12" w) & glue seams. Turf Claw™ can be shipped with your turf order. Check current pricing for tape & glue per quantity needed. If installing over macadam, be sure glue is compatible with macadam or loose lay with 2-3 lbs. sand to weigh the turf down, plus tape & glue seams. If gluing SilverBack™ polyurethane backing, make sure glue is polyurethane compatible.

For Batting Tunnels, all the above with foam backing are heavy enough to not be glued or spiked, but adding 2-3 lbs. sand per square foot is recommended for more weight to prevent shifting.

<b>#CPTCUT1</b>	Pre-Trim or Splitting Rolls - 49' roll and under	<b>\$53/EA</b>
<b>#CPTCUT2</b>	Pre-Trim or Splitting Rolls - 50' roll and over	<b>\$106/EA</b>
<b>#RVRL</b>	Reverse Rolling Synthetic Turf	<b>\$53/EA</b>

Batting Practice Mats are **recommended** for batting tunnels to reduce wear from cleats. Please see pg. 18.

Please see our **Synthetic Turf Catalog** for more options and specifications.



**YOUR "ONE-STOP" SOURCE FOR AMERICA'S BASEBALL, SOFTBALL & SPORTS SURFACES & SUPPLIES!**

PRICES SUBJECT TO CHANGE & AVAILABILITY PLUS SHIPPING | VOLUME DISCOUNTS AVAILABLE | COOPERATIVE PURCHASING CONTRACT PRICING FOR 50 STATES



**Partac Peat Corporation – Item Price Schedule**  
**Athletic Equipment & Supplies BID# ESCNJ 17/18-31 Effective 5/9/2018 - 5/8/2022**

Bidding Company Name:				Partac Peat Corporation				Catalog Name:		104 - Batting Practice			
No.	Product Category	Beam Clay Catalog Section #	Page#	Product Description	Manufacturer	Vendor SKU	Unit of Measure	Catalog List Price	Bid Discount Percentage	Discount Amt.	Net Effective Bid Price	Comments	No.
1	Baseball & Softball	104	3	Big League Bomber Portable All Star Batting Cage, Royal Blue #BMR-1RB	JAYPRO	#BMR-1RB	EACH	\$ 5,296.00	5.0%	\$ 264.80	\$ 5,031.20	+ shipping - see freight notes	1
2	Baseball & Softball	104	3	Big League Bomber Portable All Star Batting Cage, Black #BMR-1BK	JAYPRO	#BMR-1BK	EACH	\$ 5,296.00	5.0%	\$ 264.80	\$ 5,031.20	+ shipping - see freight notes	2
3	Baseball & Softball	104	3	Big League Bomber Portable All Star Batting Cage, Red #BMR-1RD	JAYPRO	#BMR-1RD	EACH	\$ 5,296.00	5.0%	\$ 264.80	\$ 5,031.20	+ shipping - see freight notes	3
4	Baseball & Softball	104	3	Big League Bomber Portable All Star Batting Cage, Green #BMR-1GR	JAYPRO	#BMR-1GR	EACH	\$ 5,296.00	5.0%	\$ 264.80	\$ 5,031.20	+ shipping - see freight notes	4
5	Baseball & Softball	104	3	Big League Bomber Portable All Star Batting Cage, Navy Blue #BMR-1NB	JAYPRO	#BMR-1NB	EACH	\$ 5,296.00	5.0%	\$ 264.80	\$ 5,031.20	+ shipping - see freight notes	5
6	Baseball & Softball	104	3	Big League Bomber Portable All Star Batting Cage, Maroon #BMR-1MR	JAYPRO	#BMR-1MR	EACH	\$ 5,296.00	5.0%	\$ 264.80	\$ 5,031.20	+ shipping - see freight notes	6
7	Baseball & Softball	104	3	Big League Bomber Portable All Star Batting Cage - Graphic Panel	JAYPRO	#SKT-LOGO	EACH	\$ 282.00	5.0%	\$ 14.10	\$ 267.90	+ shipping - see freight notes	7
8	Baseball & Softball	104	3	Replacement Parts: Skirt #5KT-75XX	JAYPRO	#5KT-75XX	EACH	\$ 509.00	5.0%	\$ 25.45	\$ 483.55	+ shipping - see freight notes	8
9	Baseball & Softball	104	3	Replacement Parts: Net #BLN-3	JAYPRO	#BLN-3	EACH	\$ 739.00	5.0%	\$ 36.95	\$ 702.05	+ shipping - see freight notes	9
10	Baseball & Softball	104	3	Replacement Parts: Thud Pad #THUD-46XX	JAYPRO	#THUD-46XX	EACH	\$ 428.00	5.0%	\$ 21.40	\$ 406.60	+ shipping - see freight notes	10
11	Baseball & Softball	104	3	RICOCHET Padding Upgrade Kit #RPAD-UKITXX	JAYPRO	#RPAD-UKITXX	EACH	\$ 297.00	5.0%	\$ 14.85	\$ 282.15	+ shipping - see freight notes	11
12	Baseball & Softball	104	4	Big League Portable Batting Cage - Bomber Elite - Royal Blue, 546 lbs. #BGLC-7500RB	JAYPRO	BGLC-7500RB	EACH	\$ 4,641.00	5.0%	\$ 232.05	\$ 4,408.95	+ shipping - see freight notes	12
13	Baseball & Softball	104	4	Big League Portable Batting Cage - Bomber Elite - Black, 546 lbs. #BGLC-7500BK	JAYPRO	BGLC-7500BK	EACH	\$ 4,641.00	5.0%	\$ 232.05	\$ 4,408.95	+ shipping - see freight notes	13
14	Baseball & Softball	104	4	Big League Portable Batting Cage - Bomber Elite - Red, 546 lbs. #BGLC-7500RD	JAYPRO	BGLC-7500RD	EACH	\$ 4,641.00	5.0%	\$ 232.05	\$ 4,408.95	+ shipping - see freight notes	14
15	Baseball & Softball	104	4	Big League Portable Batting Cage - Bomber Elite - Green, 546 lbs. #BGLC-7500GR	JAYPRO	BGLC-7500GR	EACH	\$ 4,641.00	5.0%	\$ 232.05	\$ 4,408.95	+ shipping - see freight notes	15
16	Baseball & Softball	104	4	Big League Portable Batting Cage - Bomber Elite - Navy Blue, 546 lbs. #BGLC-7500NB	JAYPRO	BGLC-7500NB	EACH	\$ 4,641.00	5.0%	\$ 232.05	\$ 4,408.95	+ shipping - see freight notes	16
17	Baseball & Softball	104	4	Big League Portable Batting Cage - Bomber Elite - Maroon, 546 lbs. #BGLC-7500MR	JAYPRO	BGLC-7500MR	EACH	\$ 4,641.00	5.0%	\$ 232.05	\$ 4,408.95	+ shipping - see freight notes	17
18	Baseball & Softball	104	4	Big League Portable Batting Cage - Replacement Parts - Skirt, 17 lbs #5KT-75XX	JAYPRO	SKT-75XX	EACH	\$ 509.00	5.0%	\$ 25.45	\$ 483.55	+ shipping - see freight notes	18
19	Baseball & Softball	104	4	Big League Portable Batting Cage - Replacement Parts - Net, 44 lbs #BLN-3	JAYPRO	BLN-3	EACH	\$ 739.00	5.0%	\$ 36.95	\$ 702.05	+ shipping - see freight notes	19
20	Baseball & Softball	104	4	Big League Portable Batting Cage - Replacement Parts - Thud Pad, 20 lbs #THUD-46XX	JAYPRO	THUD-46XX	EACH	\$ 428.00	5.0%	\$ 21.40	\$ 406.60	+ shipping - see freight notes	20
21	Baseball & Softball	104	4	Big League Portable Batting Cage - Ricochet Padding Upgrade Kit - Padding Kit #RPAD-UKITXX	JAYPRO	RPAD-UKITXX	KIT	\$ 297.00	5.0%	\$ 14.85	\$ 282.15	+ shipping - see freight notes	21
22	Baseball & Softball	104	5	Big League Portable Batting Cage - Bomber Pro - Royal Blue, 505 lbs. # BBGS-18RB	JAYPRO	BBGS-18RB	EACH	\$ 4,082.00	5.0%	\$ 204.10	\$ 3,877.90	+ shipping - see freight notes	22
23	Baseball & Softball	104	5	Big League Portable Batting Cage - Bomber Pro - Black, 505 lbs. # BBGS-18BK	JAYPRO	BBGS-18BK	EACH	\$ 4,082.00	5.0%	\$ 204.10	\$ 3,877.90	+ shipping - see freight notes	23
24	Baseball & Softball	104	5	Big League Portable Batting Cage - Bomber Pro - Red, 505 lbs. # BBGS-18RD	JAYPRO	BBGS-18RD	EACH	\$ 4,082.00	5.0%	\$ 204.10	\$ 3,877.90	+ shipping - see freight notes	24
#REF!	Baseball & Softball	104	5	Big League Portable Batting Cage - Bomber Pro - Navy Blue, 505 lbs. # BBGS-18NB	JAYPRO	BBGS-18NB	EACH	\$ 4,082.00	5.0%	\$ 204.10	\$ 3,877.90	+ shipping - see freight notes	#REF!
#REF!	Baseball & Softball	104	5	Big League Portable Batting Cage - Bomber Pro - Maroon, 505 lbs. # BBGS-18MR	JAYPRO	BBGS-18MR	EACH	\$ 4,082.00	5.0%	\$ 204.10	\$ 3,877.90	+ shipping - see freight notes	#REF!
#REF!	Baseball & Softball	104	5	Big League Portable Batting Cage - Replacement Parts - Skirt, 17 lbs #5KT-75XX	JAYPRO	SKT-75XX	EACH	\$ 509.00	5.0%	\$ 25.45	\$ 483.55	+ shipping - see freight notes	#REF!

#REF!	Baseball & Softball	104	5	Big League Portable Batting Cage - Replacement Parts - 18' x 22' x 12' Net, 44 lbs #BLN-3	JAYPRO	BLN-3	EACH	\$ 739.00	5.0%	\$ 36.95	\$ 702.05	+ shipping - see freight notes	#REF!
#REF!	Baseball & Softball	104	5	Big League Portable Batting Cage - Thud Pad #THUD-46XX	JAYPRO	#THUD-46XX	EACH	\$ 428.00	5.0%	\$ 21.40	\$ 406.60	+ shipping - see freight notes	#REF!
#REF!	Baseball & Softball	104	5	Big League Portable Batting Cage - Viewing Stand, 24 lbs #CVS-10	JAYPRO	CVS-10	EACH	\$ 565.00	5.0%	\$ 28.25	\$ 536.75	+ shipping - see freight notes	#REF!
#REF!	Baseball & Softball	104	5	Big League Portable Batting Cage - Struts (set of 6)	JAYPRO	BGLC-75STRUTS	SET	\$ 467.00	5.0%	\$ 23.35	\$ 443.65	+ shipping - see freight notes	#REF!
#REF!	Baseball & Softball	104	5	Grand Slam Portable Batting Cage - Ricochet Cushion - Black - 6' lengths, 2 lbs #BPD-6	JAYPRO	BPD-6	EACH	\$ 28.00	5.0%	\$ 1.40	\$ 26.60	+ shipping - see freight notes	#REF!
#REF!	Baseball & Softball	104	5	Weather Resistant Tape - 60 yd. rolls, 2 lbs #PDT-3	JAYPRO	PDT-3	EACH	\$ 76.00	5.0%	\$ 3.80	\$ 72.20	+ shipping - see freight notes	#REF!
#REF!	Baseball & Softball	104	3	Big League Bomber Portable All Star Batting Cage - Graphic Panel	JAYPRO	#SKT-LOGO	EACH	\$ 282.00	5.0%	\$ 14.10	\$ 267.90	+ shipping - see freight notes	#REF!
#REF!	Baseball & Softball	104	6	Big League Bomber Varsity Portable Batting Cage #BBL5-12	JAYPRO	BBL5-12	EACH	\$ 3,858.00	5.0%	\$ 192.90	\$ 3,665.10	+ shipping - see freight notes	#REF!
#REF!	Baseball & Softball	104	6	Big League Bomber Varsity Portable Batting Cage - Vinyl Skirt, 23 lbs #SKT-20XX	JAYPRO	SKT-20XX	EACH	\$ 420.00	5.0%	\$ 21.00	\$ 399.00	+ shipping - see freight notes	#REF!
#REF!	Baseball & Softball	104	6	Big League Bomber Varsity Portable Batting Cage - Viewing Stand, 24 lbs #CVS-10	JAYPRO	CVS-10	EACH	\$ 565.00	5.0%	\$ 28.25	\$ 536.75	+ shipping - see freight notes	#REF!
#REF!	Baseball & Softball	104	6	Big League Bomber Varsity Portable Batting Cage - Replacement Net, 38 lbs #LSN-2	JAYPRO	LSN-2	EACH	\$ 800.00	5.0%	\$ 40.00	\$ 760.00	+ shipping - see freight notes	#REF!
#REF!	Baseball & Softball	104	6	Big League Bomber Varsity Portable Batting Cage - Ricochet Cushion - Black - 6' lengths, 2 lbs #BPD-6	JAYPRO	BPD-6	EACH	\$ 28.00	5.0%	\$ 1.40	\$ 26.60	+ shipping - see freight notes	#REF!
#REF!	Baseball & Softball	104	6	Weather Resistant Tape - 60 yd. rolls, 2 lbs #PDT-3	JAYPRO	PDT-3	EACH	\$ 76.00	5.0%	\$ 3.80	\$ 72.20	+ shipping - see freight notes	#REF!
#REF!	Baseball & Softball	104	7	Line Drive Batting Cage, 12'H x 16'6"W x 16'6" D #BBLD-5000	JAYPRO	BBLD-5000	EACH	\$ 3,767.00	5.0%	\$ 188.35	\$ 3,578.65	+ shipping - see freight notes	#REF!
#REF!	Baseball & Softball	104	7	Line Drive Batting Cage - Replacement Line Drive Cage - 16'6"W x 12'H x 16'6"D #LDN-5	JAYPRO	LDN-5	EACH	\$ 593.00	5.0%	\$ 29.65	\$ 563.35	+ shipping - see freight notes	#REF!
#REF!	Baseball & Softball	104	7	Batting Cage Sun Canopy	JAYPRO	BBBCSC	EACH	\$ 318.00	5.0%	\$ 15.90	\$ 302.10	+ shipping - see freight notes	#REF!
#REF!	Baseball & Softball	104	8	Bubba Elite Portable/Collapsible Batting Cage #BSELITE	Athletic Connection	#BSELITE	EACH	\$ 5,590.00	5.0%	\$ 279.50	\$ 5,310.50	+ shipping - see freight notes	#REF!
#REF!	Baseball & Softball	104	8	Bubba Elite Replacement Net #BSBNT	Athletic Connection	#BSBNT	EACH	\$ 1,140.00	5.0%	\$ 57.00	\$ 1,083.00	+ shipping - see freight notes	#REF!
#REF!	Baseball & Softball	104	8	Bubba Elite Replacement 18 oz Solid Vinyl Coated Nylon Skirt - Choose Color #BSBSK	Athletic Connection	#BSBSK	EACH	\$ 295.00	5.0%	\$ 14.75	\$ 280.25	+ shipping - see freight notes	#REF!
#REF!	Baseball & Softball	104	8	Bubba Elite Replacement 20 oz. Vinyl Mesh - Choose Color #1300574	Aer-Flo	#1300574	EACH	\$ 285.00	5.0%	\$ 14.25	\$ 270.75	+ shipping - see freight notes	#REF!
#REF!	Baseball & Softball	104	8	24" High Letters 1 Color #1COL24	Aer-Flo	#1COL24	EACH	\$ 56.00	5.0%	\$ 2.80	\$ 53.20	+ shipping - see freight notes	#REF!
#REF!	Baseball & Softball	104	8	Bubba Elite Replacement Black Backstop Thud Pad #1217612DS	Athletic Connection	#1217612DS	EACH	\$ 325.00	5.0%	\$ 16.25	\$ 308.75	+ shipping - see freight notes	#REF!
#REF!	Baseball & Softball	104	8	Bubba Elite Replacement Dolley #1316681	Athletic Connection	#1316681	EACH	\$ 615.00	5.0%	\$ 30.75	\$ 584.25	+ shipping - see freight notes	#REF!
#REF!	Baseball & Softball	104	8	Bubba Elite Replacement Ricochet Cushion Padding #1273830	Athletic Connection	#1273830	EACH	\$ 48.00	5.0%	\$ 2.40	\$ 45.60	+ shipping - see freight notes	#REF!
#REF!	Baseball & Softball	104	8	Optional Foam Padding in Team Colors with Tough Skin (Choose Color) #K15324	Humphrys	#K15324	8' LENGTHS	\$ 38.00	5.0%	\$ 1.90	\$ 36.10	+ shipping - see freight notes	#REF!
#REF!	Baseball & Softball	104	8	19" Long Tie Wraps - packs of 100 (Choose Color) #K13109	Humphrys	#K13109	PACK	\$ 25.00	5.0%	\$ 1.25	\$ 23.75	+ shipping - see freight notes	#REF!
#REF!	Baseball & Softball	104	9	Big Bubba Batting Cage	Athletic Connection	#BSBUBBA	EACH	\$ 5,070.00	5.0%	\$ 253.50	\$ 4,816.50	+ shipping - see freight notes	#REF!
#REF!	Baseball & Softball	104	9	Replacement 18 oz. Solid Vinyl Nylon Skirt (Choose color) #BSBSK	Aer-Flo	#BSBSK	EACH	\$ 295.00	5.0%	\$ 14.75	\$ 280.25	+ shipping - see freight notes	#REF!
#REF!	Baseball & Softball	104	9	Replacement 20 oz. Vinyl Mesh Skirt (Choose color) #1300574	Aer-Flo	#1300574	EACH	\$ 285.00	5.0%	\$ 14.25	\$ 270.75	+ shipping - see freight notes	#REF!
#REF!	Baseball & Softball	104	9	24" High Letters 1 Color #1COL24	Aer-Flo	#1COL24	EACH	\$ 56.00	5.0%	\$ 2.80	\$ 53.20	+ shipping - see freight notes	#REF!

#REF!	Baseball & Softball	104	9	Replacement Net #K13803	Athletic Connection	#K13803	EACH	\$ 1,140.00	5.0%	\$ 57.00	\$ 1,083.00	+ shipping - see freight notes	#REF!
#REF!	Baseball & Softball	104	9	Optional Thud Pad (Choose color) #1150988	Humphrys	#1150988	EACH	\$ 325.00	5.0%	\$ 16.25	\$ 308.75	+ shipping - see freight notes	#REF!
#REF!	Baseball & Softball	104	9	Thud Pad with Graphics #1150988G	Aer-Flo	#1150988G	EACH	\$ 450.00	5.0%	\$ 22.50	\$ 427.50	+ shipping - see freight notes	#REF!
#REF!	Baseball & Softball	104	9	Replacement Black Ricochet Padding, 6' lengths #1273830	Humphrys	#1273830	6' LENGTHS	\$ 48.00	5.0%	\$ 2.40	\$ 45.60	+ shipping - see freight notes	#REF!
#REF!	Baseball & Softball	104	9	Replacement Rear Dolley Assembly with Wheel #1274042	Athletic Connection	#1274042	EACH	\$ 615.00	5.0%	\$ 30.75	\$ 584.25	+ shipping - see freight notes	#REF!
#REF!	Baseball & Softball	104	9	Replacement Set of 3 Pneumatic Wheels #K10236	Athletic Connection	#K10236	SET	\$ 165.00	5.0%	\$ 8.25	\$ 156.75	+ shipping - see freight notes	#REF!
#REF!	Baseball & Softball	104	9	Replacement Canopy Lifting Tubes with Hooks on End #ZX0210004	Athletic Connection	#ZX0210004	EACH	\$ 75.00	5.0%	\$ 3.75	\$ 71.25	+ shipping - see freight notes	#REF!
#REF!	Baseball & Softball	104	9	Optional Portable Coaches Viewing Platform #K73122	Athletic Connection	#K73122	EACH	\$ 405.00	5.0%	\$ 20.25	\$ 384.75	+ shipping - see freight notes	#REF!
#REF!	Baseball & Softball	104	9	Optional Foam Padding in Team Colors with Tough Skin (Choose Color) #K15324	Humphrys	#K15324	8' LENGTHS	\$ 38.00	5.0%	\$ 1.90	\$ 36.10	+ shipping - see freight notes	#REF!
#REF!	Baseball & Softball	104	9	19" Long Tie Wraps - packs of 100 (Choose Color) #K13109	Humphrys	#K13109	PACK	\$ 25.00	5.0%	\$ 1.25	\$ 23.75	+ shipping - see freight notes	#REF!
#REF!	Baseball & Softball	104	10	Varsity Batting Cage #BS4000F	Athletic Connection	#BS4000F	EACH	\$ 4,140.00	5.0%	\$ 207.00	\$ 3,933.00	+ shipping - see freight notes	#REF!
#REF!	Baseball & Softball	104	10	Replacement Net #BS4FNET	Athletic Connection	#BS4FNET	EACH	\$ 1,400.00	5.0%	\$ 70.00	\$ 1,330.00	+ shipping - see freight notes	#REF!
#REF!	Baseball & Softball	104	10	Replacement Rear Dolley Assembly with Wheel #1274042	Athletic Connection	#1274042	EACH	\$ 615.00	5.0%	\$ 30.75	\$ 584.25	+ shipping - see freight notes	#REF!
#REF!	Baseball & Softball	104	10	Black Replacement Ricochet Cushion Padding, 6' lengths #1273830	Athletic Connection	#1273830	6' LENGTHS	\$ 48.00	5.0%	\$ 2.40	\$ 45.60	+ shipping - see freight notes	#REF!
#REF!	Baseball & Softball	104	10	Optional Foam Padding in Team Colors with Tough Skin (Choose Color) #K15324	Athletic Connection	#K15324	8' LENGTHS	\$ 38.00	5.0%	\$ 1.90	\$ 36.10	+ shipping - see freight notes	#REF!
#REF!	Baseball & Softball	104	10	19" Long Tie Wraps - packs of 100 (Choose Color) #K13109	Athletic Connection	#K13109	PACK	\$ 25.00	5.0%	\$ 1.25	\$ 23.75	+ shipping - see freight notes	#REF!
#REF!	Baseball & Softball	104	11	Varsity Oversize Portable (Not Foldable) Baseball Batting Cage #BS4000	Athletic Connection	#BS4000	EACH	\$ 3,365.00	5.0%	\$ 168.25	\$ 3,196.75	+ shipping - see freight notes	#REF!
#REF!	Baseball & Softball	104	11	Replacement Net #BS4NET	Athletic Connection	#BS4NET	EACH	\$ 1,400.00	5.0%	\$ 70.00	\$ 1,330.00	+ shipping - see freight notes	#REF!
#REF!	Baseball & Softball	104	11	Dolley Assembly #1274042	Athletic Connection	#1274042	EACH	\$ 615.00	5.0%	\$ 30.75	\$ 584.25	+ shipping - see freight notes	#REF!
#REF!	Baseball & Softball	104	11	Ricochet Black Foam Padding, 6' lengths #1273830	Athletic Connection	#1273830	6' LENGTHS	\$ 48.00	5.0%	\$ 2.40	\$ 45.60	+ shipping - see freight notes	#REF!
#REF!	Baseball & Softball	104	11	Sandlot Portable Backstop Complete Unit #BBBSWING	Athletic Connection	#BBBSWING	EACH	\$ 2,555.00	5.0%	\$ 127.75	\$ 2,427.25	+ shipping - see freight notes	#REF!
#REF!	Baseball & Softball	104	11	Replacement Net for Back and Top #SNWINGCTDS	Athletic Connection	#SNWINGCTDS	EACH	\$ 300.00	5.0%	\$ 15.00	\$ 285.00	+ shipping - see freight notes	#REF!
#REF!	Baseball & Softball	104	11	9'H x 6' W Replacement Net for Wings (requires 2) #SNWINGSD	Athletic Connection	#SNWINGSD	EACH	\$ 160.00	5.0%	\$ 8.00	\$ 152.00	+ shipping - see freight notes	#REF!
#REF!	Baseball & Softball	104	11	Batting Cage Saver - Heavy-Duty 22 oz (Choose Color) #13153	Humphrys	#13153	EACH	\$ 125.00	5.0%	\$ 6.25	\$ 118.75	+ shipping - see freight notes	#REF!
#REF!	Baseball & Softball	104	11	Batting Cage Saver - Super-Duty 30 oz (Choose Color) #12003	Humphrys	#12003	EACH	\$ 140.00	5.0%	\$ 7.00	\$ 133.00	+ shipping - see freight notes	#REF!
#REF!	Baseball & Softball	104	12	Armor-Mesh 2-Piece Cage Collar (Choose Color) #AMCC	Humphrys	#AMCC	2-PIECE	\$ 1,125.00	5.0%	\$ 56.25	\$ 1,068.75	+ shipping - see freight notes	#REF!
#REF!	Baseball & Softball	104	12	Armor-Mesh Infield Protector (Choose Color) #AMIP	Humphrys	#AMIP	EACH	\$ 515.00	5.0%	\$ 25.75	\$ 489.25	+ shipping - see freight notes	#REF!
#REF!	Baseball & Softball	104	12	Armor-Mesh Complete Set (Choose Color) #AMCS	Humphrys	#AMCS	SET	\$ 1,530.00	5.0%	\$ 76.50	\$ 1,453.50	+ shipping - see freight notes	#REF!
#REF!	Baseball & Softball	104	13	Varsity Infield Protector Deluxe Complete Set (Choose Color) #BPZ5PCSET	Aer-Flo	#BPZ5PCSET	SET	\$ 1,595.00	5.0%	\$ 79.75	\$ 1,515.25	+ shipping - see freight notes	#REF!
#REF!	Baseball & Softball	104	13	#3533 Trapezoid infield blanket 20' Deep x 20' x 60', Wt. 85 lbs. #BPINFILDP202060	Aer-Flo	BPINFILDP202060	EACH	\$ 755.00	5.0%	\$ 37.75	\$ 717.25	+ shipping - see freight notes	#REF!

#REF!	Baseball & Softball	104	13	#3542 2 piece cage collar only, based on 30' dia cutout (sq) - U-Shaped, Wt. 82 lbs. #BPCCSQ30	Aer-Flo	BPCCSQ30	EACH	\$ 550.00	5.0%	\$ 27.50	\$ 522.50	+ shipping - see freight notes	#REF!
#REF!	Baseball & Softball	104	13	#3544 Individual 8' x 14' turf blanket, Wt. 14 lbs. #BPZTM814	Aer-Flo	BPZTM814	EACH	\$ 125.00	5.0%	\$ 6.25	\$ 118.75	+ shipping - see freight notes	#REF!
#REF!	Baseball & Softball	104	13	#3543 Individual 12' x 14' turf blanket, Wt. 20 lbs. #BPZTM1214	Aer-Flo	BPZTM1214	EACH	\$ 175.00	5.0%	\$ 8.75	\$ 166.25	+ shipping - see freight notes	#REF!
#REF!	Baseball & Softball	104	13	#3542CU Custom Cage Collar #BPCCX	Aer-Flo	BPCCX	SF	\$ 0.96	5.0%	\$ 0.05	\$ 0.91	+ shipping - see freight notes	#REF!
#REF!	Baseball & Softball	104	13	#3630 Optional 9" ground anchor stakes #JSTAKE	Aer-Flo	JSTAKE	EACH	\$ 1.25	5.0%	\$ 0.06	\$ 1.19	+ shipping - see freight notes	#REF!
#REF!	Baseball & Softball	104	13	#3631 Optional 9" ground anchor stakes, pack of 15 #JS15	Aer-Flo	#JS15	PACK	\$ 19.50	5.0%	\$ 0.98	\$ 18.53	+ shipping - see freight notes	#REF!
#REF!	Baseball & Softball	104	13	Optional 9" ground anchor stakes, pack of 30 #JS30	Aer-Flo	JS30	PACK	\$ 35.00	5.0%	\$ 1.75	\$ 33.25	+ shipping - see freight notes	#REF!
#REF!	Baseball & Softball	104	13	Optional 9" ground anchor stakes, pack of 115 #JS115	Aer-Flo	JS115	PACK	\$ 95.00	5.0%	\$ 4.75	\$ 90.25	+ shipping - see freight notes	#REF!
#REF!	Baseball & Softball	104	14	Vinyl Coated Poly Mesh Batting Practice Infield Protectors - Standard Mesh (CHOOSE COLOR) - 15' Deep x 20' Wide x 50' Across (35 lbs.) #VCPMesh15x20	Humphrys	VCP Mesh 15x20	EACH	\$ 415.00	5.0%	\$ 20.75	\$ 394.25	+ shipping - see freight notes	#REF!
#REF!	Baseball & Softball	104	14	Vinyl Coated Poly Mesh Batting Practice Infield Protectors - Standard Mesh (CHOOSE COLOR) - 15' Deep x 26' Wide x 56' Across (44 lbs.) #VCPMesh15x26	Humphrys	VCP Mesh 15x26	EACH	\$ 450.00	5.0%	\$ 22.50	\$ 427.50	+ shipping - see freight notes	#REF!
#REF!	Baseball & Softball	104	14	Vinyl Coated Poly Mesh Batting Practice Infield Protectors - Standard Mesh (CHOOSE COLOR) - 20' Deep x 20' Wide x 60' Across (46 lbs.) #VCPMesh20x20	Humphrys	VCP Mesh 20x20	EACH	\$ 520.00	5.0%	\$ 26.00	\$ 494.00	+ shipping - see freight notes	#REF!
#REF!	Baseball & Softball	104	14	Vinyl Coated Poly Mesh Batting Practice Infield Protectors - Standard Mesh (CHOOSE COLOR) - 20' Deep x 24' Wide x 64' Across (56 lbs.) #VCPMesh20x24	Humphrys	VCP Mesh 20x24	EACH	\$ 585.00	5.0%	\$ 29.25	\$ 555.75	+ shipping - see freight notes	#REF!
#REF!	Baseball & Softball	104	14	Vinyl Coated Poly Mesh Batting Practice Infield Protectors - Standard Mesh (CHOOSE COLOR) - 25' Deep x 20' Wide x 70' Across (65 lbs.) #VCPMesh25x20	Humphrys	VCP Mesh 25x20	EACH	\$ 730.00	5.0%	\$ 36.50	\$ 693.50	+ shipping - see freight notes	#REF!
#REF!	Baseball & Softball	104	14	Premium Armor Mesh Batting Practice Infield Protectors (Choose Color) - 15' Deep x 20' Wide x 50' Across (50 lbs.) #PAMesh15x20	Humphrys	PA Mesh 15x20	EACH	\$ 525.00	5.0%	\$ 26.25	\$ 498.75	+ shipping - see freight notes	#REF!
#REF!	Baseball & Softball	104	14	Premium Armor Mesh Batting Practice Infield Protectors (Choose Color) - 15' Deep x 26' Wide x 56' Across (59 lbs.) #PAMesh15x26	Humphrys	PA Mesh 15x26	EACH	\$ 570.00	5.0%	\$ 28.50	\$ 541.50	+ shipping - see freight notes	#REF!
#REF!	Baseball & Softball	104	14	Premium Armor Mesh Batting Practice Infield Protectors (Choose Color) - 20' Deep x 20' Wide x 60' Across (74 lbs.) #PAMesh20x20	Humphrys	PA Mesh 20x20	EACH	\$ 645.00	5.0%	\$ 32.25	\$ 612.75	+ shipping - see freight notes	#REF!
#REF!	Baseball & Softball	104	14	Premium Armor Mesh Batting Practice Infield Protectors (Choose Color) - 20' Deep x 24' Wide x 64' Across (81 lbs.) #PAMesh20x24	Humphrys	PA Mesh 20x24	EACH	\$ 730.00	5.0%	\$ 36.50	\$ 693.50	+ shipping - see freight notes	#REF!
#REF!	Baseball & Softball	104	14	Premium Armor Mesh Batting Practice Infield Protectors (Choose Color) - 25' Deep x 20' Wide x 70' Across (104 lbs.) #PAMesh25x20	Humphrys	PA Mesh 25x20	EACH	\$ 925.00	5.0%	\$ 46.25	\$ 878.75	+ shipping - see freight notes	#REF!
#REF!	Baseball & Softball	104	14	Tent Stakes - Steel 1/4" x 9"	Humphrys	TS Steel	EACH	\$ 0.95	5.0%	\$ 0.05	\$ 0.90	+ shipping - see freight notes	#REF!
#REF!	Baseball & Softball	104	14	Tent Stakes - Powder Coated Safety Yellow, 1/4" x 9"	Humphrys	TS PCSY	EACH	\$ 1.75	5.0%	\$ 0.09	\$ 1.66	+ shipping - see freight notes	#REF!
#REF!	Baseball & Softball	104	14	Sod Staples, u-Shaped Steel 1" x 6" Box of 1,000	Humphrys	SS/1000	BOX	\$ 75.00	5.0%	\$ 3.75	\$ 71.25	+ shipping - see freight notes	#REF!
#REF!	Baseball & Softball	104	14	Sod Staples, u-Shaped Steel 1" x 6" Package of 100	Humphrys	SS/100	PACKAGE	\$ 25.00	5.0%	\$ 1.25	\$ 23.75	+ shipping - see freight notes	#REF!
#REF!	Baseball & Softball	104	14	Sod Staples, u-Shaped Steel 1" x 6" Package of 25	Humphrys	SS/25	PACKAGE	\$ 10.00	5.0%	\$ 0.50	\$ 9.50	+ shipping - see freight notes	#REF!
#REF!	Baseball & Softball	104	14	White Aluminum Spikes	Humphrys	WAS	EACH	\$ 0.95	5.0%	\$ 0.05	\$ 0.90	+ shipping - see freight notes	#REF!
#REF!	Baseball & Softball	104	15	Mesh Infield Protectors - Basic Mesh (Choose Color) #BPINFIELDB152050 15' Deep x 20' Wide x 50' Across (28 lbs.)	Aer-Flo	BPINFIELDB152050	EACH	\$ 440.00	5.0%	\$ 22.00	\$ 418.00	+ shipping - see freight notes	#REF!
#REF!	Baseball & Softball	104	15	Mesh Infield Protectors - Basic Mesh (Choose Color) #BPINFIELDB152656 15' Deep x 26' Wide x 56' Across	Aer-Flo	BPINFIELDB152656	EACH	\$ 540.00	5.0%	\$ 27.00	\$ 513.00	+ shipping - see freight notes	#REF!
#REF!	Baseball & Softball	104	15	Mesh Infield Protectors - Basic Mesh (Choose Color) #BPINFIELDB202060 20' Deep x 20' Wide x 60' Across (46 lbs.)	Aer-Flo	BPINFIELDB202060	EACH	\$ 540.00	5.0%	\$ 27.00	\$ 513.00	+ shipping - see freight notes	#REF!
#REF!	Baseball & Softball	104	15	Mesh Infield Protectors - Basic Mesh (Choose Color) #BPINFIELDB252070 25' Deep x 20' Wide x 70' Across (69 lbs.)	Aer-Flo	BPINFIELDB252070	EACH	\$ 640.00	5.0%	\$ 32.00	\$ 608.00	+ shipping - see freight notes	#REF!
#REF!	Baseball & Softball	104	15	Mesh Infield Protectors - Basic Mesh (Choose Color) #BPINFIELDB151848 15' Deep x 18' Wide x 48' Across	Aer-Flo	BPINFIELDB151848	EACH	\$ 405.00	5.0%	\$ 20.25	\$ 384.75	+ shipping - see freight notes	#REF!
#REF!	Baseball & Softball	104	15	Mesh Infield Protectors - Basic Mesh (Choose Color) #BPINFIELDB152454 15' Deep x 24' Wide x 54' Across	Aer-Flo	BPINFIELDB152454	EACH	\$ 515.00	5.0%	\$ 25.75	\$ 489.25	+ shipping - see freight notes	#REF!

#REF!	Baseball & Softball	104	15	Mesh Infield Protectors - Basic Mesh (Choose Color) #BPINFIELDB202464 20' Deep x 24' Wide x 64' Across	Aer-Flo	BPINFIELDB202464	EACH	\$ 630.00	5.0%	\$ 31.50	\$ 598.50	+ shipping - see freight notes	#REF!
#REF!	Baseball & Softball	104	15	Mesh Infield Protectors - Basic Mesh (Choose Color) #BPINFIELDBX Custom Size	Aer-Flo	BPINFIELDBX	SQ. FT.	\$ 0.98	5.0%	\$ 0.05	\$ 0.93	+ shipping - see freight notes	#REF!
#REF!	Baseball & Softball	104	15	Mesh Infield Protectors - Premium Vipol Matrix (Choose Color) - #BPINFIELDP152050 15' Deep x 20' Wide x 50' Across (48 lbs.)	Aer-Flo	BPINFIELDP152050	EACH	\$ 595.00	5.0%	\$ 29.75	\$ 565.25	+ shipping - see freight notes	#REF!
#REF!	Baseball & Softball	104	15	Mesh Infield Protectors - Premium Vipol Matrix (Choose Color) - #BPINFIELDP202060 20' Deep x 20' Wide x 60' Across (83 lbs.)	Aer-Flo	BPINFIELDP202060	EACH	\$ 755.00	5.0%	\$ 37.75	\$ 717.25	+ shipping - see freight notes	#REF!
#REF!	Baseball & Softball	104	15	Mesh Infield Protectors - Premium Vipol Matrix (Choose Color) - #BPINFIELDP252070 25' Deep x 20' Wide x 70' Across (106lbs.)	Aer-Flo	BPINFIELDP252070	EACH	\$ 915.00	5.0%	\$ 45.75	\$ 869.25	+ shipping - see freight notes	#REF!
#REF!	Baseball & Softball	104	15	Mesh Infield Protectors - Premium Vipol Matrix (Choose Color) - #BPINFIELDP151848 15' Deep x 18' Wide x 48' Across	Aer-Flo	BPINFIELDP151848	EACH	\$ 545.00	5.0%	\$ 27.25	\$ 517.75	+ shipping - see freight notes	#REF!
#REF!	Baseball & Softball	104	15	Mesh Infield Protectors - Premium Vipol Matrix (Choose Color) - #BPINFIELDP152454 15' Deep x 24' Wide x 54' Across	Aer-Flo	BPINFIELDP152454	EACH	\$ 700.00	5.0%	\$ 35.00	\$ 665.00	+ shipping - see freight notes	#REF!
#REF!	Baseball & Softball	104	15	Mesh Infield Protectors - Premium Vipol Matrix (Choose Color) - #BPINFIELDP202464 20' Deep x 24' Wide x 64' Across	Aer-Flo	BPINFIELDP202464	EACH	\$ 890.00	5.0%	\$ 44.50	\$ 845.50	+ shipping - see freight notes	#REF!
#REF!	Baseball & Softball	104	15	Mesh Infield Protectors - Premium Vipol Matrix (Choose Color) - #BPINFIELDPX Custom Size	Aer-Flo	BPINFIELDPX	SQ. FT.	\$ 0.98	5.0%	\$ 0.05	\$ 0.93	+ shipping - see freight notes	#REF!
#REF!	Baseball & Softball	104	15	Mesh Infield Protectors - Wind Weighted Premium Vipol Matrix (Choose Color) #WWBPINFIELDP152050 15' Deep x 20' Wide x 50' Across (95 lbs.)	Aer-Flo	WWBPINFIELDP152050	EACH	\$ 730.00	5.0%	\$ 36.50	\$ 693.50	+ shipping - see freight notes	#REF!
#REF!	Baseball & Softball	104	15	Mesh Infield Protectors - Wind Weighted Premium Vipol Matrix (Choose Color) #WWBPINFIELDP202060 20' Deep x 20' Wide x 60' Across (120 lbs.)	Aer-Flo	WWBPINFIELDP202060	EACH	\$ 895.00	5.0%	\$ 44.75	\$ 850.25	+ shipping - see freight notes	#REF!
#REF!	Baseball & Softball	104	15	Mesh Infield Protectors - Wind Weighted Premium Vipol Matrix (Choose Color) #WWBPINFIELDP252070 25' Deep x 20' Wide x 70' Across (150 lbs.)	Aer-Flo	WWBPINFIELDP252070	EACH	\$ 1,185.00	5.0%	\$ 59.25	\$ 1,125.75	+ shipping - see freight notes	#REF!
#REF!	Baseball & Softball	104	15	Mesh Infield Protectors - Wind Weighted Premium Vipol Matrix (Choose Color) #WWBPINFIELDP151848 15' Deep x 18' Wide x 48' Across	Aer-Flo	WWBPINFIELDP151848	EACH	\$ 685.00	5.0%	\$ 34.25	\$ 650.75	+ shipping - see freight notes	#REF!
#REF!	Baseball & Softball	104	15	Mesh Infield Protectors - Wind Weighted Premium Vipol Matrix (Choose Color) #WWBPINFIELDP152454 15' Deep x 24' Wide x 54' Across	Aer-Flo	WWBPINFIELDP152454	EACH	\$ 815.00	5.0%	\$ 40.75	\$ 774.25	+ shipping - see freight notes	#REF!
#REF!	Baseball & Softball	104	15	Mesh Infield Protectors - Wind Weighted Premium Vipol Matrix (Choose Color) #WWBPINFIELDP202464 20' Deep x 24' Wide x 64' Across	Aer-Flo	WWBPINFIELDP202464	EACH	\$ 1,010.00	5.0%	\$ 50.50	\$ 959.50	+ shipping - see freight notes	#REF!
#REF!	Baseball & Softball	104	15	Mesh Infield Protectors - Wind Weighted Premium Vipol Matrix (Choose Color) #WWBPINFIELDPX Custom Size	Aer-Flo	WWBPINFIELDPX	SQ. FT.	\$ 2.60	5.0%	\$ 0.13	\$ 2.47	+ shipping - see freight notes	#REF!
#REF!	Baseball & Softball	104	16	CHROMA-BOND IMPRINTING 1 COLOR LOGO ONLY - UP TO 25SF - 1COL25SF	Aer-Flo	1COL25SF	EACH	\$ 550.000	5.0%	\$ 27.50	\$ 522.50	+ shipping - see freight notes	#REF!
#REF!	Baseball & Softball	104	16	CHROMA-BOND IMPRINTING 1 COLOR LOGO ONLY - 26SF-50SF - 1COL2650SF	Aer-Flo	1COL2650SF	EACH	\$ 725.000	5.0%	\$ 36.25	\$ 688.75	+ shipping - see freight notes	#REF!
#REF!	Baseball & Softball	104	16	CHROMA-BOND IMPRINTING 1 COLOR LOGO ONLY - 51SF-100SF - 1COL51100SF	Aer-Flo	1COL51100SF	EACH	\$ 995.000	5.0%	\$ 49.75	\$ 945.25	+ shipping - see freight notes	#REF!
#REF!	Baseball & Softball	104	16	CHROMA-BOND IMPRINTING 2 COLOR LOGO ONLY - UP TO 25SF - 2COL25SF	Aer-Flo	2COL25SF	EACH	\$ 675.000	5.0%	\$ 33.75	\$ 641.25	+ shipping - see freight notes	#REF!
#REF!	Baseball & Softball	104	16	CHROMA-BOND IMPRINTING 2 COLOR LOGO ONLY - 26SF-50SF - 2COL2650SF	Aer-Flo	2COL2650SF	EACH	\$ 850.000	5.0%	\$ 42.50	\$ 807.50	+ shipping - see freight notes	#REF!
#REF!	Baseball & Softball	104	16	CHROMA-BOND IMPRINTING 2 COLOR LOGO ONLY - 51SF-100SF - 2COL51100SF	Aer-Flo	2COL51100SF	EACH	\$ 1,150.000	5.0%	\$ 57.50	\$ 1,092.50	+ shipping - see freight notes	#REF!
#REF!	Baseball & Softball	104	16	CHROMA-BOND IMPRINTING 3 COLOR LOGO ONLY - UP TO 25SF - 3COL25SF	Aer-Flo	3COL25SF	EACH	\$ 760.000	5.0%	\$ 38.00	\$ 722.00	+ shipping - see freight notes	#REF!
#REF!	Baseball & Softball	104	16	CHROMA-BOND IMPRINTING 3 COLOR LOGO ONLY - 26SF-50SF - 3COL2650SF	Aer-Flo	3COL2650SF	EACH	\$ 925.000	5.0%	\$ 46.25	\$ 878.75	+ shipping - see freight notes	#REF!
#REF!	Baseball & Softball	104	16	CHROMA-BOND IMPRINTING 3 COLOR LOGO ONLY - 51SF-100SF - 3COL51100SF	Aer-Flo	3COL51100SF	EACH	\$ 1,215.000	5.0%	\$ 60.75	\$ 1,154.25	+ shipping - see freight notes	#REF!
#REF!	Baseball & Softball	104	16	CHROMA-BOND IMPRINTING 1 COLOR LTRS. OR NUMBERS - UP TO 24" TALL - 1COL24	Aer-Flo	1COL24	EACH	\$ 56.000	5.0%	\$ 2.80	\$ 53.20	+ shipping - see freight notes	#REF!
#REF!	Baseball & Softball	104	16	CHROMA-BOND IMPRINTING 1 COLOR LTRS. OR NUMBERS - UP TO 36" TALL - 1COL36	Aer-Flo	1COL36	EACH	\$ 68.000	5.0%	\$ 3.40	\$ 64.60	+ shipping - see freight notes	#REF!
#REF!	Baseball & Softball	104	16	CHROMA-BOND IMPRINTING 1 COLOR LTRS. OR NUMBERS - UP TO 48" TALL - 1COL48	Aer-Flo	1COL48	EACH	\$ 84.000	5.0%	\$ 4.20	\$ 79.80	+ shipping - see freight notes	#REF!
#REF!	Baseball & Softball	104	16	CHROMA-BOND IMPRINTING 1 COLOR LTRS. OR NUMBERS - UP TO 60" TALL - 1COL60	Aer-Flo	1COL60	EACH	\$ 98.000	5.0%	\$ 4.90	\$ 93.10	+ shipping - see freight notes	#REF!
#REF!	Baseball & Softball	104	16	CHROMA-BOND IMPRINTING 1 COLOR LTRS. OR NUMBERS - UP TO 72" TALL - 1COL72	Aer-Flo	1COL72	EACH	\$ 120.000	5.0%	\$ 6.00	\$ 114.00	+ shipping - see freight notes	#REF!

#REF!	Baseball & Softball	104	16	CHROMA-BOND IMPRINTING 1 COLOR LTRS. OR NUMBERS - UP TO 84" TALL - 1COL84	Aer-Flo	1COL84	EACH	\$ 131.000	5.0%	\$ 6.55	\$ 124.45	+ shipping - see freight notes	#REF!
#REF!	Baseball & Softball	104	16	CHROMA-BOND IMPRINTING 1 COLOR LTRS. OR NUMBERS - UP TO 96" TALL - 1COL96	Aer-Flo	1COL96	EACH	\$ 150.000	5.0%	\$ 7.50	\$ 142.50	+ shipping - see freight notes	#REF!
#REF!	Baseball & Softball	104	16	CHROMA-BOND IMPRINTING 1 COLOR LTRS. OR NUMBERS - UP TO 108" TALL - 1COL108	Aer-Flo	1COL108	EACH	\$ 178.000	5.0%	\$ 8.90	\$ 169.10	+ shipping - see freight notes	#REF!
#REF!	Baseball & Softball	104	16	CHROMA-BOND IMPRINTING 1 COLOR LTRS. OR NUMBERS - UP TO 120" TALL - 1COL120	Aer-Flo	1COL120	EACH	\$ 206.000	5.0%	\$ 10.30	\$ 195.70	+ shipping - see freight notes	#REF!
#REF!	Baseball & Softball	104	16	CHROMA-BOND IMPRINTING 2 COLOR LTRS. OR NUMBERS - UP TO 24" TALL - 2COL24	Aer-Flo	2COL24	EACH	\$ 76.000	5.0%	\$ 3.80	\$ 72.20	+ shipping - see freight notes	#REF!
#REF!	Baseball & Softball	104	16	CHROMA-BOND IMPRINTING 2 COLOR LTRS. OR NUMBERS - UP TO 36" TALL - 2COL36	Aer-Flo	2COL36	EACH	\$ 88.000	5.0%	\$ 4.40	\$ 83.60	+ shipping - see freight notes	#REF!
#REF!	Baseball & Softball	104	16	CHROMA-BOND IMPRINTING 2 COLOR LTRS. OR NUMBERS - UP TO 48" TALL - 2COL48	Aer-Flo	2COL48	EACH	\$ 104.000	5.0%	\$ 5.20	\$ 98.80	+ shipping - see freight notes	#REF!
#REF!	Baseball & Softball	104	16	CHROMA-BOND IMPRINTING 2 COLOR LTRS. OR NUMBERS - UP TO 60" TALL - 2COL60	Aer-Flo	2COL60	EACH	\$ 118.000	5.0%	\$ 5.90	\$ 112.10	+ shipping - see freight notes	#REF!
#REF!	Baseball & Softball	104	16	CHROMA-BOND IMPRINTING 2 COLOR LTRS. OR NUMBERS - UP TO 72" TALL - 2COL72	Aer-Flo	2COL72	EACH	\$ 139.000	5.0%	\$ 6.95	\$ 132.05	+ shipping - see freight notes	#REF!
#REF!	Baseball & Softball	104	16	CHROMA-BOND IMPRINTING 2 COLOR LTRS. OR NUMBERS - UP TO 84" TALL - 2COL84	Aer-Flo	2COL84	EACH	\$ 151.000	5.0%	\$ 7.55	\$ 143.45	+ shipping - see freight notes	#REF!
#REF!	Baseball & Softball	104	16	CHROMA-BOND IMPRINTING 2 COLOR LTRS. OR NUMBERS - UP TO 96" TALL - 2COL96	Aer-Flo	2COL96	EACH	\$ 171.000	5.0%	\$ 8.55	\$ 162.45	+ shipping - see freight notes	#REF!
#REF!	Baseball & Softball	104	16	CHROMA-BOND IMPRINTING 2 COLOR LTRS. OR NUMBERS - UP TO 108" TALL - 2COL108	Aer-Flo	2COL108	EACH	\$ 198.000	5.0%	\$ 9.90	\$ 188.10	+ shipping - see freight notes	#REF!
#REF!	Baseball & Softball	104	16	CHROMA-BOND IMPRINTING 2 COLOR LTRS. OR NUMBERS - UP TO 120" TALL - 2COL120	Aer-Flo	2COL120	EACH	\$ 226.000	5.0%	\$ 11.30	\$ 214.70	+ shipping - see freight notes	#REF!
#REF!	Baseball & Softball	104	17	Bunt Zone Infield Protector Trainer: Standard Size - Large	Aer-Flo	BUNTZNMRNLG	EACH	\$ 775.00	5.0%	\$ 38.75	\$ 736.25	+ shipping - see freight notes	#REF!
#REF!	Baseball & Softball	104	17	Bunt Zone Infield Protector Trainer: Standard Size - Medium	Aer-Flo	BUNTZNMRNLMD	EACH	\$ 670.00	5.0%	\$ 33.50	\$ 636.50	+ shipping - see freight notes	#REF!
#REF!	Baseball & Softball	104	17	Bunt Zone Infield Protector Trainer: Standard Size - Little League/Softball	Aer-Flo	BUNTZNMRNSM	EACH	\$ 580.00	5.0%	\$ 29.00	\$ 551.00	+ shipping - see freight notes	#REF!
#REF!	Baseball & Softball	104	17	Bunt Zone Infield Protector Trainer: Major League Style - Large	Aer-Flo	BUNTZNMLLG	EACH	\$ 840.00	5.0%	\$ 42.00	\$ 798.00	+ shipping - see freight notes	#REF!
#REF!	Baseball & Softball	104	17	Bunt Zone Infield Protector Trainer: Major League Style - Medium	Aer-Flo	BUNTZNMLMD	EACH	\$ 735.00	5.0%	\$ 36.75	\$ 698.25	+ shipping - see freight notes	#REF!
#REF!	Baseball & Softball	104	17	Bunt Zone Infield Protector Trainer: Major League Style - Little League/Softball	Aer-Flo	BUNTZNMLSM	EACH	\$ 635.00	5.0%	\$ 31.75	\$ 603.25	+ shipping - see freight notes	#REF!
#REF!	Baseball & Softball	104	18	Artificial Turf Batting Practice Mat - ST-1P - Baseball Home Plate (6' x 12') with batter's box lines and home plate both in permanent white turf—Green	CP Turf	ST-1P	EACH	\$ 345.00	5.0%	\$ 17.25	\$ 327.75	+ shipping - see freight notes	#REF!
#REF!	Baseball & Softball	104	18	Artificial Turf Batting Practice Mat - ST-1PC - Baseball Home Plate (6' x 12') with batter's box lines and home plate both in permanent white turf—Colors	CP Turf	ST-1PC	EACH	\$ 395.00	5.0%	\$ 19.75	\$ 375.25	+ shipping - see freight notes	#REF!
#REF!	Baseball & Softball	104	18	Artificial Turf Batting Practice Mat - ST-1 - Baseball Home Plate (6' x 12') with permanent white turf batter's box lines - NO PLATE - use with throw down home plate so mat can be rotated—Green	CP Turf	ST-1	EACH	\$ 315.00	5.0%	\$ 15.75	\$ 299.25	+ shipping - see freight notes	#REF!
#REF!	Baseball & Softball	104	18	Artificial Turf Batting Practice Mat - ST-1C - Baseball Home Plate (6' x 12') with permanent white turf batter's box lines - NO PLATE - use with throw down home plate so mat can be rotated—Colors	CP Turf	ST-1C	EACH	\$ 355.00	5.0%	\$ 17.75	\$ 337.25	+ shipping - see freight notes	#REF!
#REF!	Baseball & Softball	104	18	Artificial Turf Batting Practice Mat - ST-712P - Baseball/Softball Home Plate (7' x 12') with 4' x 7' permanent white turf batter's box lines (not 3' x 7') and Home Plate—Green	CP Turf	ST-712P	EACH	\$ 425.00	5.0%	\$ 21.25	\$ 403.75	+ shipping - see freight notes	#REF!
#REF!	Baseball & Softball	104	18	Artificial Turf Batting Practice Mat - ST-712PC - Baseball/Softball Home Plate (7' x 12') with 4' x 7' permanent white turf batter's box lines (not 3' x 7') and Home Plate—Colors	CP Turf	ST-712PC	EACH	\$ 465.00	5.0%	\$ 23.25	\$ 441.75	+ shipping - see freight notes	#REF!
#REF!	Baseball & Softball	104	18	Artificial Turf Batting Practice Mat - ST-712P-1 - Baseball/Softball Home Plate (7' x 12') with 4' x 7' permanent white turf batter's box lines (not 3' x 7') NO PLATE—use with throw down home plate so mat can be rotated - Green	CP Turf	ST-712P-1	EACH	\$ 385.00	5.0%	\$ 19.25	\$ 365.75	+ shipping - see freight notes	#REF!
#REF!	Baseball & Softball	104	18	Artificial Turf Batting Practice Mat - ST-712PC-1 - Baseball/Softball Home Plate (7' x 12') with 4' x 7' permanent white turf batter's box lines (not 3' x 7') NO PLATE—use with throw down home plate so mat can be rotated—Colors	CP Turf	ST-712PC-1	EACH	\$ 415.00	5.0%	\$ 20.75	\$ 394.25	+ shipping - see freight notes	#REF!
#REF!	Baseball & Softball	104	18	Artificial Turf Batting Practice Mat - ST-15BG - Softball Home Plate (7' x 12') Plain - Green	CP Turf	ST-15BG	EACH	\$ 345.00	5.0%	\$ 17.25	\$ 327.75	+ shipping - see freight notes	#REF!
#REF!	Baseball & Softball	104	18	Artificial Turf Batting Practice Mat - ST-15BC - Softball Home Plate (7' x 12') Plain - Colors	CP Turf	ST-15BC	EACH	\$ 365.00	5.0%	\$ 18.25	\$ 346.75	+ shipping - see freight notes	#REF!
#REF!	Baseball & Softball	104	18	Artificial Turf Batting Practice Mat - ST-2G - Pitcher's Mat (6' x 12') - Green	CP Turf	ST-2G	EACH	\$ 325.00	5.0%	\$ 16.25	\$ 308.75	+ shipping - see freight notes	#REF!

#REF!	Baseball & Softball	104	18	Artificial Turf Batting Practice Mat - ST-2C - Pitcher's Mat (6' x 12') - Colors	CP Turf	ST-2C	EACH	\$ 345.00	5.0%	\$ 17.25	\$ 327.75	+ shipping - see freight notes	#REF!
#REF!	Baseball & Softball	104	18	Artificial Turf Batting Practice Mat - ST-2A-G - Pitcher's Mat (4' x 12') - Green	CP Turf	ST-2A-G	EACH	\$ 245.00	5.0%	\$ 12.25	\$ 232.75	+ shipping - see freight notes	#REF!
#REF!	Baseball & Softball	104	18	Artificial Turf Batting Practice Mat - ST-2A-C - Pitcher's Mat (4' x 12') - Colors	CP Turf	ST-2A-C	EACH	\$ 265.00	5.0%	\$ 13.25	\$ 251.75	+ shipping - see freight notes	#REF!
#REF!	Baseball & Softball	104	18	Artificial Turf Batting Practice Mat - ST-3 - Multi-Purpose Mat (4' x 6')	CP Turf	ST-3	EACH	\$ 160.00	5.0%	\$ 8.00	\$ 152.00	+ shipping - see freight notes	#REF!
#REF!	Baseball & Softball	104	18	Artificial Turf Batting Practice Mat - ST-3A - Multi-Purpose Mat (3' x 7')	CP Turf	ST-3A	EACH	\$ 145.00	5.0%	\$ 7.25	\$ 137.75	+ shipping - see freight notes	#REF!
#REF!	Baseball & Softball	104	18	Artificial Turf Batting Practice Mat - ST-3B - Multi-Purpose Mat (4' x 7')	CP Turf	ST-3B	EACH	\$ 175.00	5.0%	\$ 8.75	\$ 166.25	+ shipping - see freight notes	#REF!
#REF!	Baseball & Softball	104	18	Artificial Turf Batting Practice Mat - ST-3C - Multi-Purpose Mat (6' x 9')	CP Turf	ST-3C	EACH	\$ 275.00	5.0%	\$ 13.75	\$ 261.25	+ shipping - see freight notes	#REF!
#REF!	Baseball & Softball	104	18	Artificial Turf Batting Practice Mat - ST-BPM - Bullpen Mat (12' x 12') Plain	CP Turf	ST-BPM	EACH	\$ 675.00	5.0%	\$ 33.75	\$ 641.25	+ shipping - see freight notes	#REF!
#REF!	Baseball & Softball	104	18	Artificial Turf Batting Practice Mat - ST-CB1 - Coaches Box Mat (6' x 12')	CP Turf	ST-CB1	EACH	\$ 325.00	5.0%	\$ 16.25	\$ 308.75	+ shipping - see freight notes	#REF!
#REF!	Baseball & Softball	104	18	Artificial Turf Batting Practice Mat - ST-4 - Set of 2 On-Deck/Fungo Circles (4' diameter) - Green	CP Turf	ST-4	EACH	\$ 265.00	5.0%	\$ 13.25	\$ 251.75	+ shipping - see freight notes	#REF!
#REF!	Baseball & Softball	104	18	Artificial Turf Batting Practice Mat - ST-4C - Set of 2 On-Deck/Fungo Circles (4' diameter) - Colors	CP Turf	ST-4C	EACH	\$ 285.00	5.0%	\$ 14.25	\$ 270.75	+ shipping - see freight notes	#REF!
#REF!	Baseball & Softball	104	18	Artificial Turf Batting Practice Mat - ST-5 - Set of 2 On-Deck/Fungo Circles (5' diameter) - Green	CP Turf	ST-5	EACH	\$ 315.00	5.0%	\$ 15.75	\$ 299.25	+ shipping - see freight notes	#REF!
#REF!	Baseball & Softball	104	18	Artificial Turf Batting Practice Mat - ST-5C - Set of 2 On-Deck/Fungo Circles (5' diameter) - Colors	CP Turf	ST-5C	EACH	\$ 345.00	5.0%	\$ 17.25	\$ 327.75	+ shipping - see freight notes	#REF!
#REF!	Baseball & Softball	104	18	Artificial Turf Batting Practice Mat - ST-6 - Set of 2 On-Deck/Fungo Circles (6' diameter) - Green	CP Turf	ST-6	EACH	\$ 355.00	5.0%	\$ 17.75	\$ 337.25	+ shipping - see freight notes	#REF!
#REF!	Baseball & Softball	104	18	Artificial Turf Batting Practice Mat - ST-6C - Set of 2 On-Deck/Fungo Circles (6' diameter) - Colors	CP Turf	ST-6C	EACH	\$ 375.00	5.0%	\$ 18.75	\$ 356.25	+ shipping - see freight notes	#REF!
#REF!	Baseball & Softball	104	19	Professional Batting Tunnel Frame and Netting - 55' / 70' / 75' Model	Douglas	#66214	EACH	\$ 3,695.00	5.0%	\$ 184.75	\$ 3,510.25	+ shipping - see freight notes	#REF!
#REF!	Baseball & Softball	104	19	Professional Batting Tunnel Frame and Netting - Double Model (side by side)	Douglas	#66214D	EACH	\$ 6,160.00	5.0%	\$ 308.00	\$ 5,852.00	+ shipping - see freight notes	#REF!
#REF!	Baseball & Softball	104	19	#48 Premium Knotted Braided Solid Core Poly Black Tunnel Netting - 12'H x 14'W x 70'L	Douglas	#36035	EACH	\$ 1,385.00	5.0%	\$ 69.25	\$ 1,315.75	+ shipping - see freight notes	#REF!
#REF!	Baseball & Softball	104	19	#48 Premium Knotted Braided Solid Core Poly Black Tunnel Netting - 12'H x 12'W x 70'L	Douglas	#36033	EACH	\$ 1,305.00	5.0%	\$ 65.25	\$ 1,239.75		
#REF!	Baseball & Softball	104	19	#48 Premium Knotted Braided Solid Core Poly Black Tunnel Netting - 12'H x 12'W x 75'L	Douglas	#36039	EACH	\$ 1,460.00	5.0%	\$ 73.00	\$ 1,387.00		
#REF!	Baseball & Softball	104	19	#48 Premium Knotted Braided Solid Core Poly Black Tunnel Netting - 12'H x 12'W x 55'L	Douglas	#36038	EACH	\$ 1,000.00	5.0%	\$ 50.00	\$ 950.00		
#REF!	Baseball & Softball	104	19	#48 Premium Knotted Braided Solid Core Poly Black Tunnel Netting - 12'H x 14'W x 55'L	Douglas	#36036	EACH	\$ 1,075.00	5.0%	\$ 53.75	\$ 1,021.25	+ shipping - see freight notes	#REF!
#REF!	Baseball & Softball	104	19	#42 Premium Knotted Twisted Solid Core Poly Black Tunnel Netting - 12'H x 12'W x 35'L	Douglas	#36042	EACH	\$ 460.00	5.0%	\$ 23.00	\$ 437.00		
#REF!	Baseball & Softball	104	19	#42 Premium Knotted Twisted Solid Core Poly Black Tunnel Netting - 12'H x 12'W x 55'L	Douglas	#36048	EACH	\$ 615.00	5.0%	\$ 30.75	\$ 584.25		
#REF!	Baseball & Softball	104	19	#42 Premium Knotted Twisted Solid Core Poly Black Tunnel Netting - 12'H x 14'W x 55'L	Douglas	#36046	EACH	\$ 745.00	5.0%	\$ 37.25	\$ 707.75		
#REF!	Baseball & Softball	104	19	#42 Premium Knotted Twisted Solid Core Poly Black Tunnel Netting - 12'H x 12'W x 70'L	Douglas	#36043	EACH	\$ 770.00	5.0%	\$ 38.50	\$ 731.50		
#REF!	Baseball & Softball	104	19	#42 Premium Knotted Twisted Solid Core Poly Black Tunnel Netting - 12'H x 14'W x 70'L	Douglas	#36045	EACH	\$ 845.00	5.0%	\$ 42.25	\$ 802.75		
#REF!	Baseball & Softball	104	19	#42 Premium Knotted Twisted Solid Core Poly Black Tunnel Netting - 12'H x 14'W x 75'L	Douglas	#36049	EACH	\$ 920.00	5.0%				
#REF!	Baseball & Softball	104	20	Protective Net Saver or Divider	Douglas	#36060	EACH	\$ 116.00	5.0%	\$ 5.80	\$ 110.20	+ shipping - see freight notes	#REF!
#REF!	Baseball & Softball	104	20	Protective Net Saver or Divider	Douglas	#36062	EACH	\$ 100.00	5.0%	\$ 5.00	\$ 95.00	+ shipping - see freight notes	#REF!

#REF!	Baseball & Softball	104	20	Indoor Batting Tunnel Tensioning Kit	Douglas	#66200	EACH	\$ 1,385.00	5.0%	\$ 69.25	\$ 1,315.75	+ shipping - see freight notes	#REF!
#REF!	Baseball & Softball	104	20	20.5 oz. Batting Tunnel Floor Covers	Douglas	#29250	EACH	\$ 770.00	5.0%	\$ 38.50	\$ 731.50	+ shipping - see freight notes	#REF!
#REF!	Baseball & Softball	104	20	20.5 oz. Batting Tunnel Floor Covers	Douglas	#29255	EACH	\$ 920.00	5.0%	\$ 46.00	\$ 874.00	+ shipping - see freight notes	#REF!
#REF!	Baseball & Softball	104	20	Indoor Ceiling Suspension Kit	Douglas	#66219	KIT	\$ 615.00	5.0%	\$ 30.75	\$ 584.25	+ shipping - see freight notes	#REF!
#REF!	Baseball & Softball	104	20	Indoor Accessory Cable Hardware Kit	Douglas	#66213	KIT	\$ 460.00	5.0%	\$ 23.00	\$ 437.00	+ shipping - see freight notes	#REF!
#REF!	Baseball & Softball	104	21	Hitting Station Systems 70'/75' Model	Douglas	#66270	EACH	\$ 2,155.00	5.0%	\$ 107.75	\$ 2,047.25	+ shipping - see freight notes	#REF!
#REF!	Baseball & Softball	104	21	Hitting Station Systems 55' Model	Douglas	#66255	EACH	\$ 1,385.00	5.0%	\$ 69.25	\$ 1,315.75	+ shipping - see freight notes	#REF!
#REF!	Baseball & Softball	104	21	Protective Net Saver or Divider	Douglas	#36062	EACH	\$ 100.00	5.0%	\$ 5.00	\$ 95.00	+ shipping - see freight notes	#REF!
#REF!	Baseball & Softball	104	21	Protective Net Saver or Divider	Douglas	#36060	EACH	\$ 115.00	5.0%	\$ 5.75	\$ 109.25	+ shipping - see freight notes	#REF!
#REF!	Baseball & Softball	104	21	Thud Pad - 68"W x 52"H x 4" Thick	Aer-Flo	1217612DS	EACH	\$ 325.00	5.0%	\$ 16.25	\$ 308.75	+ shipping - see freight notes	#REF!
#REF!	Baseball & Softball	104	21	Batting Tunnel Net Protector Pads: 3'W x 4'H x 1-1/2" Thick	Aer-Flo	200180453	EACH	\$ 145.00	5.0%	\$ 7.25	\$ 137.75	+ shipping - see freight notes	#REF!
#REF!	Baseball & Softball	104	22	Vinyl Batting Tunnel/Batting Cage Hitting Backdrops - 18 oz. (Choose Color)	Humphreys	VBT-18OZ	EACH	\$ 35.00	5.0%	\$ 1.75	\$ 33.25	+ shipping - see freight notes	#REF!
#REF!	Baseball & Softball	104	22	Vinyl Batting Tunnel/Batting Cage Hitting Backdrops - 22 oz. (Choose Color)	Humphreys	VBT-22OZ	EACH	\$ 115.00	5.0%	\$ 5.75	\$ 109.25	+ shipping - see freight notes	#REF!
#REF!	Baseball & Softball	104	22	Vinyl Batting Tunnel/Batting Cage Hitting Backdrops - 30 oz. (Choose Color)	Humphreys	VBT-30OZ	EACH	\$ 125.00	5.0%	\$ 6.25	\$ 118.75	+ shipping - see freight notes	#REF!
#REF!	Baseball & Softball	104	22	Cage Saver Target	Jaypro	CST65	EACH	\$ 105.00	5.0%	\$ 5.25	\$ 99.75	+ shipping - see freight notes	#REF!
#REF!	Baseball & Softball	104	22	VINYL BATTING TUNNEL / BATTING CAGE TARGET BACKDROP PROTECTORS - 7'H X 5'W 22 OZ. CAGE SAVER DRK GRN WITH WHITE TARGET #CS22-DGW	Aer-Flo	CS22-DGW	EACH	\$ 135.00	5.0%	\$ 6.75	\$ 128.25	+ shipping - see freight notes	#REF!
#REF!	Baseball & Softball	104	22	VINYL BATTING TUNNEL / BATTING CAGE TARGET BACKDROP PROTECTORS - 7'H X 5'W 22 OZ. CAGE SAVER ROYAL WITH WHITE TARGET #CS22-RBW	Aer-Flo	CS22-RBW	EACH	\$ 135.00	5.0%	\$ 6.75	\$ 128.25	+ shipping - see freight notes	#REF!
#REF!	Baseball & Softball	104	22	VINYL BATTING TUNNEL / BATTING CAGE TARGET BACKDROP PROTECTORS - 7'H X 5'W 22 OZ. CAGE SAVER RED WITH WHITE TARGET #CS22-RW	Aer-Flo	CS22-RW	EACH	\$ 135.00	5.0%	\$ 6.75	\$ 128.25	+ shipping - see freight notes	#REF!
#REF!	Baseball & Softball	104	22	VINYL BATTING TUNNEL / BATTING CAGE TARGET BACKDROP PROTECTORS - 7'H X 5'W 22 OZ. CAGE SAVER DK GRN NO TARGET #CS22-NOTARGET-DG	Aer-Flo	CS22-NOTARGET-DG	EACH	\$ 105.00	5.0%	\$ 5.25	\$ 99.75	+ shipping - see freight notes	#REF!
#REF!	Baseball & Softball	104	22	VINYL BATTING TUNNEL / BATTING CAGE TARGET BACKDROP PROTECTORS - 7'H X 5'W 22 OZ. CAGE SAVER ROYAL NO TARGET #CS22-NOTARGET-RB	Aer-Flo	CS22-NOTARGET-RB	EACH	\$ 105.00	5.0%	\$ 5.25	\$ 99.75	+ shipping - see freight notes	#REF!
#REF!	Baseball & Softball	104	22	VINYL BATTING TUNNEL / BATTING CAGE TARGET BACKDROP PROTECTORS - 7'H X 5'W 22 OZ. CAGE SAVER RED NO TARGET #CS22-NOTARGET-RD	Aer-Flo	CS22-NOTARGET-RD	EACH	\$ 105.00	5.0%	\$ 5.25	\$ 99.75	+ shipping - see freight notes	#REF!
#REF!	Baseball & Softball	104	22	VINYL BATTING TUNNEL / BATTING CAGE TARGET BACKDROP PROTECTORS - 7'H X 5'W 30 OZ. CAGE SAVER BLACK W/ ORANGE TARGET #CS30-BO	Aer-Flo	CS30-BO	EACH	\$ 155.00	5.0%	\$ 7.75	\$ 147.25	+ shipping - see freight notes	#REF!
#REF!	Baseball & Softball	104	22	VINYL BATTING TUNNEL / BATTING CAGE TARGET BACKDROP PROTECTORS - 7'H X 5'W 30 OZ. CAGE SAVER NAVY WITH YELLOW TARGET #CS30-NY	Aer-Flo	CS30-NY	EACH	\$ 155.00	5.0%	\$ 7.75	\$ 147.25	+ shipping - see freight notes	#REF!
#REF!	Baseball & Softball	104	22	VINYL BATTING TUNNEL / BATTING CAGE TARGET BACKDROP PROTECTORS - 7'H X 5'W 30 OZ. CAGE SAVER ROYAL WITH YELLOW TARGET #CS30-RY	Aer-Flo	CS30-RY	EACH	\$ 155.00	5.0%	\$ 7.75	\$ 147.25	+ shipping - see freight notes	#REF!
#REF!	Baseball & Softball	104	23	1/4" Cable, Galvanized	Douglas	#34728	EACH	\$ 0.46	5.0%	\$ 0.02	\$ 0.44	+ shipping - see freight notes	#REF!
#REF!	Baseball & Softball	104	23	1/8" Cable, Galvanized	Douglas	#15102	EACH	\$ 0.31	5.0%	\$ 0.02	\$ 0.29	+ shipping - see freight notes	#REF!
#REF!	Baseball & Softball	104	23	1/4" Cable Clamp	Douglas	#34725	EACH	\$ 0.62	5.0%	\$ 0.03	\$ 0.59	+ shipping - see freight notes	#REF!
#REF!	Baseball & Softball	104	23	1/8" Cable Clamp	Douglas	#34726	EACH	\$ 0.47	5.0%	\$ 0.02	\$ 0.45	+ shipping - see freight notes	#REF!
#REF!	Baseball & Softball	104	23	12" Turnbuckle	Douglas	#34724	EACH	\$ 35.00	5.0%	\$ 1.75	\$ 33.25	+ shipping - see freight notes	#REF!
#REF!	Baseball & Softball	104	23	6" Turnbuckle	Douglas	#36986	EACH	\$ 25.00	5.0%	\$ 1.25	\$ 23.75	+ shipping - see freight notes	#REF!



#REF!	Baseball & Softball	104	23	C-Snap, Black Plated Steel	Douglas	#32670	EACH	\$ 0.74	5.0%	\$ 0.04	\$ 0.70	+ shipping - see freight notes	#REF!
#REF!	Baseball & Softball	104	23	C-Snap, Black Plastic	Douglas	#32675	EACH	\$ 0.40	5.0%	\$ 0.02	\$ 0.38	+ shipping - see freight notes	#REF!
#REF!	Baseball & Softball	104	23	8 mm Spring Link (Carabiner)	Douglas	#36000	EACH	\$ 0.89	5.0%	\$ 0.04	\$ 0.85	+ shipping - see freight notes	#REF!
#REF!	Baseball & Softball	104	23	5 mm Spring Link (Carabiner)	Douglas	#32679	EACH	\$ 0.49	5.0%	\$ 0.02	\$ 0.47	+ shipping - see freight notes	#REF!
#REF!	Baseball & Softball	104	23	3" S-Hook, Steel	Douglas	#31663	EACH	\$ 0.45	5.0%	\$ 0.02	\$ 0.43	+ shipping - see freight notes	#REF!
#REF!	Baseball & Softball	104	23	3/16" Polypro Braided Rope	Douglas	#31601M	EACH	\$ 45.95	5.0%	\$ 2.30	\$ 43.65	+ shipping - see freight notes	#REF!
#REF!	Baseball & Softball	104	23	7.5" Steel Ground Pin	Douglas	#41208	EACH	\$ 0.55	5.0%	\$ 0.03	\$ 0.52	+ shipping - see freight notes	#REF!
#REF!	Baseball & Softball	104	23	6" Eye Bolt	Douglas	#34730	EACH	\$ 9.25	5.0%	\$ 0.46	\$ 8.79	+ shipping - see freight notes	#REF!
#REF!	Baseball & Softball	104	24	Aluminum Frame Batting Tunnel - 14'H x 14'W x 55'L	AAE	BT141455	EACH	\$ 6,565.00	5.0%	\$ 328.25	\$ 6,236.75	+ shipping - see freight notes	#REF!
#REF!	Baseball & Softball	104	24	Aluminum Frame Batting Tunnel - 12'H x 14'W x 70'L	AAE	BT121470	EACH	\$ 6,915.00	5.0%	\$ 345.75	\$ 6,569.25	+ shipping - see freight notes	#REF!
#REF!	Baseball & Softball	104	24	Dual and Triple Batting Tunnel - 14'H x 14'W x 55'L	AAE	BT141455-DUAL	EACH	\$ 15,630.00	5.0%	\$ 781.50	\$ 14,848.50	+ shipping - see freight notes	#REF!
#REF!	Baseball & Softball	104	24	Dual and Triple Batting Tunnel - 12'H x 14'W x 70'L	AAE	BT121470-DUAL	EACH	\$ 17,180.00	5.0%	\$ 859.00	\$ 16,321.00	+ shipping - see freight notes	#REF!
#REF!	Baseball & Softball	104	24	Batting Tunnel EZ Zipper Entrance	AAE	BTEZ	EACH	\$ 150.00	5.0%	\$ 7.50	\$ 142.50	+ shipping - see freight notes	#REF!
#REF!	Baseball & Softball	104	24	Portable Batting Tunnel - 14'H x 14'W x 55'L	AAE	BT141455-P	EACH	\$ 16,930.00	5.0%	\$ 846.50	\$ 16,083.50	+ shipping - see freight notes	#REF!
#REF!	Baseball & Softball	104	24	Portable Batting Tunnel - 12'H x 14'W x 70'L	AAE	BT121470-P	EACH	\$ 17,705.00	5.0%	\$ 885.25	\$ 16,819.75	+ shipping - see freight notes	#REF!
#REF!	Baseball & Softball	104	25	Professional Outdoor Batting Tunnel Frames - 70'L x 12'H, 400 lbs #PROTF-70	JAYPRO	PROTF-70	EACH	\$ 4,520.00	5.0%	\$ 226.00	\$ 4,294.00	+ shipping - see freight notes	#REF!
#REF!	Baseball & Softball	104	25	Professional Outdoor Batting Tunnel Frames - 55'L x 12'H, 350 lbs #PROTF-55	JAYPRO	PROTF-55	EACH	\$ 4,140.00	5.0%	\$ 207.00	\$ 3,933.00	+ shipping - see freight notes	#REF!
#REF!	Baseball & Softball	104	25	Professional Tandem Outdoor Batting Tunnel Frames - 70'L x 12'H, 800 lbs #PROTF-70T	JAYPRO	PROTF-70T	EACH	\$ 6,401.00	5.0%	\$ 320.05	\$ 6,080.95	+ shipping - see freight notes	#REF!
#REF!	Baseball & Softball	104	25	Professional Tandem Outdoor Batting Tunnel Frames - 55'L x 12'H, 750 lbs #PROTF-55T	JAYPRO	PROTF-55T	EACH	\$ 5,364.00	5.0%	\$ 268.20	\$ 5,095.80	+ shipping - see freight notes	#REF!
#REF!	Baseball & Softball	104	26	MEGA Outdoor Batting Tunnel Frames - Single 55', 1,100 lbs #MPCTF-55S	JAYPRO	MPCTF-55S	EACH	\$ 5,644.00	5.0%	\$ 282.20	\$ 5,361.80	+ shipping - see freight notes	#REF!
#REF!	Baseball & Softball	104	26	MEGA Outdoor Batting Tunnel Frames - Double 55', 1,700 lbs #MPCTF-55D	JAYPRO	MPCTF-55D	EACH	\$ 9,535.00	5.0%	\$ 476.75	\$ 9,058.25	+ shipping - see freight notes	#REF!
#REF!	Baseball & Softball	104	26	MEGA Outdoor Batting Tunnel Frames - Single 70', 1,150 lbs #MPCTF-70S	JAYPRO	MPCTF-70S	EACH	\$ 5,905.00	5.0%	\$ 295.25	\$ 5,609.75	+ shipping - see freight notes	#REF!
#REF!	Baseball & Softball	104	26	MEGA Outdoor Batting Tunnel Frames - Double 70', 1,800 lbs #MPCTF-70D	JAYPRO	MPCTF-70D	EACH	\$ 9,893.00	5.0%	\$ 494.65	\$ 9,398.35	+ shipping - see freight notes	#REF!
#REF!	Baseball & Softball	104	26	Semi-Permanent Outdoor Batting Tunnel Frames - 5 Wickets - 70'L x 12'H, 418 lbs #BBTF-70	JAYPRO	BBTF-70	EACH	\$ 2,312.00	5.0%	\$ 115.60	\$ 2,196.40	+ shipping - see freight notes	#REF!
#REF!	Baseball & Softball	104	26	Semi-Permanent Outdoor Batting Tunnel Frames - 4 Wickets - 55'L x 12'H, 400 lbs #BBTF-55	JAYPRO	BBTF-55	EACH	\$ 1,879.00	5.0%	\$ 93.95	\$ 1,785.05	+ shipping - see freight notes	#REF!
#REF!	Baseball & Softball	104	26	Surface-Mounted Outdoor Batting Tunnel Frames - 5 Wickets - 70'L x 12'H, 250 lbs #BBTFSM-70	JAYPRO	BBTFSM-70	EACH	\$ 2,023.00	5.0%	\$ 101.15	\$ 1,921.85	+ shipping - see freight notes	#REF!
#REF!	Baseball & Softball	104	26	Surface-Mounted Outdoor Batting Tunnel Frames - 4 Wickets - 55'L x 12'H, 225 lbs #BBTFSM-55	JAYPRO	BBTFSM-55	EACH	\$ 1,433.00	5.0%	\$ 71.65	\$ 1,361.35	+ shipping - see freight notes	#REF!
#REF!	Baseball & Softball	104	27	Batting Tunnel Nets - All-Star Series Tunnel Nylon Nets - 70'L x 14'W x 12'H - #BBC36-7014	JAYPRO	BBC36-7014	EACH	\$ 1,127.00	5.0%	\$ 56.35	\$ 1,070.65	+ shipping - see freight notes	#REF!
#REF!	Baseball & Softball	104	27	Batting Tunnel Nets - All-Star Series Tunnel Nylon Nets - 70'L x 12'W x 12'H - #BBC36-7014	JAYPRO	BBC36-7012	EACH	\$ 1,221.00	5.0%	\$ 61.05	\$ 1,159.95	+ shipping - see freight notes	#REF!
#REF!	Baseball & Softball	104	27	Batting Tunnel Nets - All-Star Series Tunnel Nylon Nets - 55'L x 14'W x 12'H - #BBC36-5514	JAYPRO	BBC36-5514	EACH	\$ 1,410.00	5.0%	\$ 70.50	\$ 1,339.50	+ shipping - see freight notes	#REF!

#REF!	Baseball & Softball	104	27	Batting Tunnel Nets - All-Star Series Tunnel Nylon Nets - 55'L x 12'W x 12'H - #BBC36-5512	JAYPRO	BBC36-5512	EACH	\$ 1,503.00	5.0%	\$ 75.15	\$ 1,427.85	+ shipping - see freight notes	#REF!
#REF!	Baseball & Softball	104	27	Batting Tunnel Nets - Pro Climatized Tunnel Nets - 70'L x 14'W x 12'H - #BBCP-7014	JAYPRO	BBCP-7014	EACH	\$ 1,202.00	5.0%	\$ 60.10	\$ 1,141.90	+ shipping - see freight notes	#REF!
#REF!	Baseball & Softball	104	27	Batting Tunnel Nets - Pro Climatized Tunnel Nets - 70'L x 12'W x 12'H - #BBCP-7012	JAYPRO	BBCP-7012	EACH	\$ 1,088.00	5.0%	\$ 54.40	\$ 1,033.60	+ shipping - see freight notes	#REF!
#REF!	Baseball & Softball	104	27	Batting Tunnel Nets - Pro Climatized Tunnel Nets - 55'L x 14'W x 12'H - #BBCP-5514	JAYPRO	BBCP-5514	EACH	\$ 970.00	5.0%	\$ 48.50	\$ 921.50	+ shipping - see freight notes	#REF!
#REF!	Baseball & Softball	104	27	Batting Tunnel Nets - Pro Climatized Tunnel Nets - 55'L x 12'W x 12'H - BBCP-5512	JAYPRO	BBCP-5512	EACH	\$ 886.00	5.0%	\$ 44.30	\$ 841.70	+ shipping - see freight notes	#REF!
#REF!	Baseball & Softball	104	27	Batting Tunnel Nets - Collegiate Climatized Tunnel Nets - 70'L x 14'W x 12'H - #BBCC-7014	JAYPRO	BBCC-7014	EACH	\$ 715.00	5.0%	\$ 35.75	\$ 679.25	+ shipping - see freight notes	#REF!
#REF!	Baseball & Softball	104	27	Batting Tunnel Nets - Collegiate Climatized Tunnel Nets - 70'L x 12'W x 12'H - #BBCC-7012	JAYPRO	BBCC-7012	EACH	\$ 705.00	5.0%	\$ 35.25	\$ 669.75	+ shipping - see freight notes	#REF!
#REF!	Baseball & Softball	104	27	Batting Tunnels - Weighted Tunnel Sand TUBES #SWB-TUBE	JAYPRO	SWB-TUBE	EACH	\$ 74.00	5.0%	\$ 3.70	\$ 70.30	+ shipping - see freight notes	#REF!
#REF!	Baseball & Softball	104	28	Collegiate Tunnel Nets - ALL-STAR SERIES TUNNELS - 3.5mm, 1-3/4" black nylon netting - 55'L x 14'W x 12'H #1245059DS	Athletic Connection	1245059DS	EACH	\$ 2,055.00	5.0%	\$ 102.75	\$ 1,952.25	+ shipping - see freight notes	#REF!
#REF!	Baseball & Softball	104	28	Collegiate Tunnel Nets - ALL-STAR SERIES TUNNELS - 3.5mm, 1-3/4" black nylon netting - 70'L x 12'W x 12'H #1245042DS	Athletic Connection	1245042DS	EACH	\$ 2,170.00	5.0%	\$ 108.50	\$ 2,061.50	+ shipping - see freight notes	#REF!
#REF!	Baseball & Softball	104	28	Collegiate Tunnel Nets - ALL-STAR SERIES TUNNELS - 3.5mm, 1-3/4" black nylon netting - 70'L x 14'W x 12'H #1245035DS	Athletic Connection	1245035DS	EACH	\$ 2,310.00	5.0%	\$ 115.50	\$ 2,194.50	+ shipping - see freight notes	#REF!
#REF!	Baseball & Softball	104	28	Varsity Tunnel Nets - 2.5mm, #42 Twisted Knotted Polyethylene - 70'L x 14'W x 12'H #1149340	Athletic Connection	#1149340	EACH	\$ 1,380.00	5.0%	\$ 69.00	\$ 1,311.00	+ shipping - see freight notes	#REF!
#REF!	Baseball & Softball	104	28	Varsity Tunnel Nets - 2.5mm, #42 Twisted Knotted Polyethylene - 70'L x 12'W x 12'H #1149357	Athletic Connection	#1149357	EACH	\$ 1,205.00	5.0%	\$ 60.25	\$ 1,144.75	+ shipping - see freight notes	#REF!
#REF!	Baseball & Softball	104	28	Varsity Tunnel Nets - 2.5mm - 2.5mm, #42 Twisted Knotted Polyethylene - 55'L x 14'W x 14'H #1242478	Athletic Connection	#1242478	EACH	\$ 1,055.00	5.0%	\$ 52.75	\$ 1,002.25	+ shipping - see freight notes	#REF!
#REF!	Baseball & Softball	104	28	Varsity Tunnel Nets - 2.5mm, #42 Twisted Knotted Polyethylene - 55'L x 14'W x 12'H #1149371	Athletic Connection	#1149371	EACH	\$ 1,000.00	5.0%	\$ 50.00	\$ 950.00	+ shipping - see freight notes	#REF!
#REF!	Baseball & Softball	104	28	Varsity Tunnel Nets - 2.5mm, #42 Twisted Knotted Polyethylene - 55'L x 12'W x 12'H	Athletic Connection	#1149364	EACH	\$ 990.00	5.0%	\$ 49.50	\$ 940.50	+ shipping - see freight notes	#REF!
#REF!	Baseball & Softball	104	28	Varsity Tunnel Nets - 2.0mm Twisted Knotted polyethylene - 70'L x 14'W x 12'H #1149388	Athletic Connection	#1149388	EACH	\$ 990.00	5.0%	\$ 49.50	\$ 940.50	+ shipping - see freight notes	#REF!
#REF!	Baseball & Softball	104	28	Varsity Tunnel Nets - 2.0mm Twisted Knotted polyethylene - 70'L x 12'W x 12'H #1149401	Athletic Connection	#1149401	EACH	\$ 875.00	5.0%	\$ 43.75	\$ 831.25	+ shipping - see freight notes	#REF!
#REF!	Baseball & Softball	104	28	Varsity Tunnel Nets - 2.0mm Twisted Knotted polyethylene - 55'L x 14'W x 14'H #1241044	Athletic Connection	#1241044	EACH	\$ 935.00	5.0%	\$ 46.75	\$ 888.25	+ shipping - see freight notes	#REF!
#REF!	Baseball & Softball	104	28	Varsity Tunnel Nets - 2.0mm Twisted Knotted polyethylene - 55'L x 14'W x 12'H #1149395	Athletic Connection	#1149395	EACH	\$ 875.00	5.0%	\$ 43.75	\$ 831.25	+ shipping - see freight notes	#REF!
#REF!	Baseball & Softball	104	28	Varsity Tunnel Nets - 2.0mm Twisted Knotted polyethylene - 35'L x 14'W x 12'H #1241037	Athletic Connection	#1241037	EACH	\$ 630.00	5.0%	\$ 31.50	\$ 598.50	+ shipping - see freight notes	#REF!
#REF!	Baseball & Softball	104	28	Varsity Tunnel Nets - 2.5mm, #42 Twisted Knotted Polyethylene - 70'L x 14'W x 12'H #BS37014	Athletic Connection	#BS10004	KIT	\$ 1,735.00	5.0%	\$ 86.75	\$ 1,648.25	+ shipping - see freight notes	#REF!
#REF!	Baseball & Softball	104	28	Varsity Tunnel Nets - 2.5mm, #42 Twisted Knotted Polyethylene - 70'L x 12'W x 12'H #BS37012	Athletic Connection	#BS10000	KIT	\$ 1,485.00	5.0%	\$ 74.25	\$ 1,410.75	+ shipping - see freight notes	#REF!
#REF!	Baseball & Softball	104	28	Hardware Repl. Only #BBFRMHDW	Athletic Connection	#BBFRMHDW	EACH	\$ 345.00	5.0%	\$ 17.25	\$ 327.75	+ shipping - see freight notes	#REF!
#REF!	Baseball & Softball	104	29	Pro-Tunnel Frames - 3 Section Frame - Surface Mount	Athletic Connection	#1253634	EACH	\$ 3,055.00	5.0%	\$ 152.75	\$ 2,902.25	+ shipping - see freight notes	#REF!
#REF!	Baseball & Softball	104	29	Pro-Tunnel Frames - 4 Section Frame - Surface Mount	Athletic Connection	#1274639	EACH	\$ 3,565.00	5.0%	\$ 178.25	\$ 3,386.75	+ shipping - see freight notes	#REF!
#REF!	Baseball & Softball	104	29	Pro-Tunnel Frames - 3 Section Frame -In Ground	Athletic Connection	#1375091	EACH	\$ 2,555.00	5.0%	\$ 127.75	\$ 2,427.25	+ shipping - see freight notes	#REF!
#REF!	Baseball & Softball	104	29	Pro-Tunnel Frames - 4 Section Frame -In Ground	Athletic Connection	1375092	EACH	\$ 3,185.00	5.0%	\$ 159.25	\$ 3,025.75	+ shipping - see freight notes	#REF!
#REF!	Baseball & Softball	104	29	Ground Sleeves (optional)	Athletic Connection	1375093	EACH	\$ 130.00	5.0%	\$ 6.50	\$ 123.50	+ shipping - see freight notes	#REF!
#REF!	Baseball & Softball	104	29	Batting Cage Door	Athletic Connection	K50651	EACH	\$ 335.00	5.0%	\$ 16.75	\$ 318.25	+ shipping - see freight notes	#REF!

#REF!	Baseball & Softball	104	29	Batting Cage Zip Door	TSI	#BP2IPD	EACH	\$ 165.00	5.0%	\$ 8.25	\$ 156.75	+ shipping - see freight notes	#REF!
#REF!	Baseball & Softball	104	30	Batco Indoor/Outdoor Fold Up Batting Tunnel	Batco	#36214	EACH	\$ 6,015.00	5.0%	\$ 300.75	\$ 5,714.25	+ shipping - see freight notes	#REF!
#REF!	Baseball & Softball	104	30	Batco Indoor/Outdoor Fold Up Batting Tunnel	Batco	#36216	EACH	\$ 5,235.00	5.0%	\$ 261.75	\$ 4,973.25	+ shipping - see freight notes	#REF!
#REF!	Baseball & Softball	104	31	VARSITY BATTING CAGE FRAMES - CAGE 1: 70' L x 14'W x 12'H #FR100	JUGS	FR100	EACH	\$ 1,265.00	5.0%	\$ 63.25	\$ 1,201.75	+ shipping - see freight notes	#REF!
#REF!	Baseball & Softball	104	31	VARSITY BATTING CAGE FRAMES - CAGE 1: 70' L x 14'W x 12'H #FR105	JUGS	FR105	EACH	\$ 2,010.00	5.0%	\$ 100.50	\$ 1,909.50	+ shipping - see freight notes	#REF!
#REF!	Baseball & Softball	104	31	VARSITY BATTING CAGE FRAMES - CAGE 2: 55' L x 14'W x 12'H #FR200	JUGS	FR200	EACH	\$ 1,265.00	5.0%	\$ 63.25	\$ 1,201.75	+ shipping - see freight notes	#REF!
#REF!	Baseball & Softball	104	31	VARSITY BATTING CAGE FRAMES - CAGE 2: 55' L x 14'W x 12'H #FR205	JUGS	FR205	EACH	\$ 1,645.00	5.0%	\$ 82.25	\$ 1,562.75	+ shipping - see freight notes	#REF!
#REF!	Baseball & Softball	104	31	VARSITY BATTING CAGE FRAMES - CAGE 3: 55' L x 14'W x 16'H #FR300	JUGS	FR300	EACH	\$ 1,560.00	5.0%	\$ 78.00	\$ 1,482.00	+ shipping - see freight notes	#REF!
#REF!	Baseball & Softball	104	31	VARSITY BATTING CAGE FRAMES - CAGE 3: 55' L x 14'W x 16'H #FR305	JUGS	FR305	EACH	\$ 2,065.00	5.0%	\$ 103.25	\$ 1,961.75	+ shipping - see freight notes	#REF!
#REF!	Baseball & Softball	104	31	VARSITY BATTING CAGE FRAMES - CAGE 4: 35' L x 14'W x 14'H #FR405	JUGS	FR405	EACH	\$ 1,250.00	5.0%	\$ 62.50	\$ 1,187.50	+ shipping - see freight notes	#REF!
#REF!	Baseball & Softball	104	31	VARSITY BATTING CAGE FRAMES - CAGE 5: 70' L x 14'W x 16'H #FR505	JUGS	FR505	EACH	\$ 2,450.00	5.0%	\$ 122.50	\$ 2,327.50	+ shipping - see freight notes	#REF!
#REF!	Baseball & Softball	104	31	VARSITY BATTING CAGE FRAMES - CAGE 7: 65' L x 11'W x 11'H #FR700	JUGS	FR700	EACH	\$ 1,240.00	5.0%	\$ 62.00	\$ 1,178.00	+ shipping - see freight notes	#REF!
#REF!	Baseball & Softball	104	31	VARSITY BATTING CAGE FRAMES - CAGE 7: 65' L x 11'W x 11'H #FR705	JUGS	FR705	EACH	\$ 1,890.00	5.0%	\$ 94.50	\$ 1,795.50	+ shipping - see freight notes	#REF!
#REF!	Baseball & Softball	104	31	VARSITY BATTING CAGE FRAMES - CAGE 8: 55' L x 11'W x 11'H #FR800	JUGS	FR800	EACH	\$ 1,240.00	5.0%	\$ 62.00	\$ 1,178.00	+ shipping - see freight notes	#REF!
#REF!	Baseball & Softball	104	31	VARSITY BATTING CAGE FRAMES - CAGE 8: 55' L x 11'W x 11'H #FR805	JUGS	FR805	EACH	\$ 1,535.00	5.0%	\$ 76.75	\$ 1,458.25	+ shipping - see freight notes	#REF!
#REF!	Baseball & Softball	104	31	VARSITY BATTING CAGE FRAMES - CAGE 9: 70' L x 12'W x 12'H #FR190	JUGS	FR190	EACH	\$ 1,240.00	5.0%	\$ 62.00	\$ 1,178.00	+ shipping - see freight notes	#REF!
#REF!	Baseball & Softball	104	31	VARSITY BATTING CAGE FRAMES - CAGE 9: 70' L x 12'W x 12'H #FR195	JUGS	FR195	EACH	\$ 1,975.00	5.0%	\$ 98.75	\$ 1,876.25	+ shipping - see freight notes	#REF!
#REF!	Baseball & Softball	104	31	VARSITY BATTING CAGE FRAMES - CAGE 10: 55' L x 12'W x 12'H #FR290	JUGS	FR290	EACH	\$ 1,265.00	5.0%	\$ 63.25	\$ 1,201.75	+ shipping - see freight notes	#REF!
#REF!	Baseball & Softball	104	31	VARSITY BATTING CAGE FRAMES - CAGE 10: 55' L x 12'W x 12'H #FR295	JUGS	FR295	EACH	\$ 1,595.00	5.0%	\$ 79.75	\$ 1,515.25	+ shipping - see freight notes	#REF!
#REF!	Baseball & Softball	104	31	VARSITY BATTING CAGE FRAMES - SPLIT CAGE™ 70' L x 14'W x 12'H #FR105	JUGS	FR105	EACH	\$ 2,010.00	5.0%	\$ 100.50	\$ 1,909.50	+ shipping - see freight notes	#REF!
#REF!	Baseball & Softball	104	31	Net Installation Kits - Indoor Installation Kit #N8000	JUGS	N8000	KIT	\$ 105.00	5.0%	\$ 5.25	\$ 99.75	+ shipping - see freight notes	#REF!
#REF!	Baseball & Softball	104	31	Net Installation Kits - Optional Outdoor Installation Kit #N8010	JUGS	N8010	KIT	\$ 105.00	5.0%	\$ 5.25	\$ 99.75	+ shipping - see freight notes	#REF!
#REF!	Baseball & Softball	104	31	Net Installation Kits - Ceiling Installation Kit #N8005	JUGS	N8005	KIT	\$ 365.00	5.0%	\$ 18.25	\$ 346.75	+ shipping - see freight notes	#REF!
#REF!	Baseball & Softball	104	32	Varsity Batting Cage Nets - CAGE 1: 70' L x 14' W x 12' H - #27 Polyethylene #N1110	JUGS	N1110	EACH	\$ 645.00	5.0%	\$ 32.25	\$ 612.75	+ shipping - see freight notes	#REF!
#REF!	Baseball & Softball	104	32	Varsity Batting Cage Nets - CAGE 1: 70' L x 14' W x 12' H - #42 Polyethylene #N1000	JUGS	N1000	EACH	\$ 975.00	5.0%	\$ 48.75	\$ 926.25	+ shipping - see freight notes	#REF!
#REF!	Baseball & Softball	104	32	Varsity Batting Cage Nets - CAGE 1: 70' L x 14' W x 12' H - #60 Polyethylene #N1005	JUGS	N1005	EACH	\$ 1,205.00	5.0%	\$ 60.25	\$ 1,144.75	+ shipping - see freight notes	#REF!
#REF!	Baseball & Softball	104	32	Varsity Batting Cage Nets - CAGE 1: 70' L x 14' W x 12' H - #96 POLYESTER #N1007	JUGS	N1007	EACH	\$ 2,085.00	5.0%	\$ 104.25	\$ 1,980.75	+ shipping - see freight notes	#REF!
#REF!	Baseball & Softball	104	32	Varsity Batting Cage Nets - CAGE 2: 55' L x 14' W x 12' H - #27 Polyethylene #N2110	JUGS	N2110	EACH	\$ 545.00	5.0%	\$ 27.25	\$ 517.75	+ shipping - see freight notes	#REF!
#REF!	Baseball & Softball	104	32	Varsity Batting Cage Nets - CAGE 2: 55' L x 14' W x 12' H - #42 Polyethylene #N2000	JUGS	N2000	EACH	\$ 800.00	5.0%	\$ 40.00	\$ 760.00	+ shipping - see freight notes	#REF!
#REF!	Baseball & Softball	104	32	Varsity Batting Cage Nets - CAGE 2: 55' L x 14' W x 12' H - #60 Polyethylene #N2005	JUGS	N2005	EACH	\$ 1,120.00	5.0%	\$ 56.00	\$ 1,064.00	+ shipping - see freight notes	#REF!

#REF!	Baseball & Softball	104	32	Varsity Batting Cage Nets - CAGE 2: 55' L x 14' W x 12' H - #96 POLYESTER #N2007	JUGS	N2007	EACH	\$ 1,735.00	5.0%	\$ 86.75	\$ 1,648.25	+ shipping - see freight notes	#REF!
#REF!	Baseball & Softball	104	32	Varsity Batting Cage Nets - CAGE 3: 55' L x 14' W x 16' H - #42 Polyethylene #N3000	JUGS	N3000	EACH	\$ 900.00	5.0%	\$ 45.00	\$ 855.00	+ shipping - see freight notes	#REF!
#REF!	Baseball & Softball	104	32	Varsity Batting Cage Nets - CAGE 3: 55' L x 14' W x 16' H - #60 Polyethylene #N3005	JUGS	N3005	EACH	\$ 1,340.00	5.0%	\$ 67.00	\$ 1,273.00	+ shipping - see freight notes	#REF!
#REF!	Baseball & Softball	104	32	Varsity Batting Cage Nets - CAGE 3: 55' L x 14' W x 16' H - #96 POLYESTER #N3007	JUGS	N3007	EACH	\$ 2,010.00	5.0%	\$ 100.50	\$ 1,909.50	+ shipping - see freight notes	#REF!
#REF!	Baseball & Softball	104	32	Varsity Batting Cage Nets - CAGE 4: 35' L x 14' W x 14' H - #42 Polyethylene #N4000	JUGS	N4000	EACH	\$ 645.00	5.0%	\$ 32.25	\$ 612.75	+ shipping - see freight notes	#REF!
#REF!	Baseball & Softball	104	32	Varsity Batting Cage Nets - CAGE 4: 35' L x 14' W x 14' H - #60 Polyethylene #N4005	JUGS	N4005	EACH	\$ 875.00	5.0%	\$ 43.75	\$ 831.25	+ shipping - see freight notes	#REF!
#REF!	Baseball & Softball	104	32	Varsity Batting Cage Nets - CAGE 4: 35' L x 14' W x 14' H - #96 POLYESTER #N4007	JUGS	N4007	EACH	\$ 1,395.00	5.0%	\$ 69.75	\$ 1,325.25	+ shipping - see freight notes	#REF!
#REF!	Baseball & Softball	104	32	Varsity Batting Cage Nets - CAGE 5: 70' L x 14' W x 16' H - #42 Polyethylene #N5000	JUGS	N5000	EACH	\$ 1,120.00	5.0%	\$ 56.00	\$ 1,064.00	+ shipping - see freight notes	#REF!
#REF!	Baseball & Softball	104	32	Varsity Batting Cage Nets - CAGE 5: 70' L x 14' W x 16' H - #60 Polyethylene #N5005	JUGS	N5005	EACH	\$ 1,615.00	5.0%	\$ 80.75	\$ 1,534.25	+ shipping - see freight notes	#REF!
#REF!	Baseball & Softball	104	32	Varsity Batting Cage Nets - CAGE 5: 70' L x 14' W x 16' H - #96 POLYESTER #N5007	JUGS	N5007	EACH	\$ 2,395.00	5.0%	\$ 119.75	\$ 2,275.25	+ shipping - see freight notes	#REF!
#REF!	Baseball & Softball	104	32	Varsity Batting Cage Nets - CAGE 7: 65' L x 11' W x 11' H - #27 Polyethylene #N7310	JUGS	N7310	EACH	\$ 545.00	5.0%	\$ 27.25	\$ 517.75	+ shipping - see freight notes	#REF!
#REF!	Baseball & Softball	104	32	Varsity Batting Cage Nets - CAGE 7: 65' L x 11' W x 11' H - #42 Polyethylene #N7200	JUGS	N7200	EACH	\$ 800.00	5.0%	\$ 40.00	\$ 760.00	+ shipping - see freight notes	#REF!
#REF!	Baseball & Softball	104	32	Varsity Batting Cage Nets - CAGE 7: 65' L x 11' W x 11' H - #60 Polyethylene #N7205	JUGS	N7205	EACH	\$ 1,120.00	5.0%	\$ 56.00	\$ 1,064.00	+ shipping - see freight notes	#REF!
#REF!	Baseball & Softball	104	32	Varsity Batting Cage Nets - CAGE 7: 65' L x 11' W x 11' H - #96 POLYESTER #N7207	JUGS	N7207	EACH	\$ 1,755.00	5.0%	\$ 87.75	\$ 1,667.25	+ shipping - see freight notes	#REF!
#REF!	Baseball & Softball	104	32	Varsity Batting Cage Nets - CAGE 8: 55' L x 11' W x 11' H - #42 Polyethylene #N8100	JUGS	N8100	EACH	\$ 690.00	5.0%	\$ 34.50	\$ 655.50	+ shipping - see freight notes	#REF!
#REF!	Baseball & Softball	104	32	Varsity Batting Cage Nets - CAGE 8: 55' L x 11' W x 11' H - #60 Polyethylene #N8105	JUGS	N8105	EACH	\$ 975.00	5.0%	\$ 48.75	\$ 926.25	+ shipping - see freight notes	#REF!
#REF!	Baseball & Softball	104	32	Varsity Batting Cage Nets - CAGE 8: 55' L x 11' W x 11' H - #96 POLYESTER #N8107	JUGS	N8107	EACH	\$ 1,525.00	5.0%	\$ 76.25	\$ 1,448.75	+ shipping - see freight notes	#REF!
#REF!	Baseball & Softball	104	32	Varsity Batting Cage Nets - CAGE 9: 70' L x 12' W x 12' H - #42 Polyethylene #N1900	JUGS	N1900	EACH	\$ 910.00	5.0%	\$ 45.50	\$ 864.50	+ shipping - see freight notes	#REF!
#REF!	Baseball & Softball	104	32	Varsity Batting Cage Nets - CAGE 9: 70' L x 12' W x 12' H - #60 Polyethylene #N1905	JUGS	N1905	EACH	\$ 1,285.00	5.0%	\$ 64.25	\$ 1,220.75	+ shipping - see freight notes	#REF!
#REF!	Baseball & Softball	104	32	Varsity Batting Cage Nets - CAGE 9: 70' L x 12' W x 12' H - #96 POLYESTER #N1907	JUGS	N1907	EACH	\$ 1,920.00	5.0%	\$ 96.00	\$ 1,824.00	+ shipping - see freight notes	#REF!
#REF!	Baseball & Softball	104	32	Varsity Batting Cage Nets - CAGE 10: 55' L x 12' W x 12' H - #27 Polyethylene #N2910	JUGS	N2910	EACH	\$ 490.00	5.0%	\$ 24.50	\$ 465.50	+ shipping - see freight notes	#REF!
#REF!	Baseball & Softball	104	32	Varsity Batting Cage Nets - CAGE 10: 55' L x 12' W x 12' H - #42 Polyethylene #N2900	JUGS	N2900	EACH	\$ 765.00	5.0%	\$ 38.25	\$ 726.75	+ shipping - see freight notes	#REF!
#REF!	Baseball & Softball	104	32	Varsity Batting Cage Nets - CAGE 10: 55' L x 12' W x 12' H - #60 Polyethylene #N2905	JUGS	N2905	EACH	\$ 1,120.00	5.0%	\$ 56.00	\$ 1,064.00	+ shipping - see freight notes	#REF!
#REF!	Baseball & Softball	104	32	Varsity Batting Cage Nets - CAGE 10: 55' L x 12' W x 12' H - #96 POLYESTER #N2907	JUGS	N2907	EACH	\$ 1,615.00	5.0%	\$ 80.75	\$ 1,534.25	+ shipping - see freight notes	#REF!
#REF!	Baseball & Softball	104	32	Varsity Batting Cage Nets - Split Cage™ - 70' L x 14' W x 12' H - #96 POLYESTER #N1010	JUGS	N1010	EACH	\$ 3,210.00	5.0%	\$ 160.50	\$ 3,049.50	+ shipping - see freight notes	#REF!
#REF!	Baseball & Softball	104	34	Hit at Home® Backyard Batting Cage - 45'L x 11'W x 11'H - A5030	JUGS	A5030	EACH	\$ 875.00	5.0%	\$ 43.75	\$ 831.25	+ shipping - see freight notes	#REF!
#REF!	Baseball & Softball	104	35	Multi-Sport Instant Cage A5010	JUGS	A5010	EACH	\$ 765.00	5.0%	\$ 38.25	\$ 726.75	+ shipping - see freight notes	#REF!
#REF!	Baseball & Softball	104	35	Portable Free-Standing Sports Cage A5005	JUGS	A5005	EACH	\$ 1,755.00	5.0%	\$ 87.75	\$ 1,667.25	+ shipping - see freight notes	#REF!
#REF!	Baseball & Softball	104	36	DESIGNATED HITTER—PRO #TA2131R Red 5'9" Tall Pro Model	ProMounds	#TA2131R	EACH	\$ 345.00	5.0%	\$ 17.25	\$ 327.75	+ shipping - see freight notes	#REF!
#REF!	Baseball & Softball	104	36	DESIGNATED HITTER—PRO #TA2131B Blue 5'9" Tall Pro Model	ProMounds	#TA2131B	EACH	\$ 345.00	5.0%	\$ 17.25	\$ 327.75	+ shipping - see freight notes	#REF!

#REF!	Baseball & Softball	104	36	DESIGNATED HITTER—PRO #TA2131G Grey 5'9" Tall Pro Model	ProMounds	#TA2131G	EACH	\$ 345.00	5.0%	\$ 17.25	\$ 327.75	+ shipping - see freight notes	#REF!
#REF!	Baseball & Softball	104	36	DESIGNATED HITTER—YOUTH #TA2132R Red 5'2" Tall Youth Model	ProMounds	#TA2132R	EACH	\$ 345.00	5.0%	\$ 17.25	\$ 327.75	+ shipping - see freight notes	#REF!
#REF!	Baseball & Softball	104	36	DESIGNATED HITTER—YOUTH #TA2132B Blue 5'2" Tall Youth Model	ProMounds	#TA2132B	EACH	\$ 345.00	5.0%	\$ 17.25	\$ 327.75	+ shipping - see freight notes	#REF!
#REF!	Baseball & Softball	104	36	DESIGNATED HITTER—YOUTH #TA2132G Grey 5'2" Tall Youth Model	ProMounds	#TA2132G	EACH	\$ 345.00	5.0%	\$ 17.25	\$ 327.75	+ shipping - see freight notes	#REF!
#REF!	Baseball & Softball	104	38	JUGS - Pitching Machines -Baseball Pitching Machine with Changeup - BP3 M1030	JUGS	M1030	EACH	\$ 4,235.00	5.0%	\$ 211.75	\$ 4,023.25	+ shipping - see freight notes	#REF!
#REF!	Baseball & Softball	104	38	JUGS - Pitching Machines -Softball (NEW) Pitching Machine with Changeup - BP3 M1035	JUGS	M1035	EACH	\$ 4,235.00	5.0%	\$ 211.75	\$ 4,023.25	+ shipping - see freight notes	#REF!
#REF!	Baseball & Softball	104	40	JUGS - Pitching Machines -Baseball Pitching Machine - BP2 M1020	JUGS	M1020	EACH	\$ 3,075.00	5.0%	\$ 153.75	\$ 2,921.25	+ shipping - see freight notes	#REF!
#REF!	Baseball & Softball	104	42	Changeup Super Softball™ Pitching Machine M1251	JUGS	M1251	EACH	\$ 2,305.00	5.0%	\$ 115.25	\$ 2,189.75	+ shipping - see freight notes	#REF!
#REF!	Baseball & Softball	104	42	Changeup Super Softball™ Pitching Machine With Transport cart M1250	JUGS	M1250	EACH	\$ 2,415.00	5.0%	\$ 120.75	\$ 2,294.25	+ shipping - see freight notes	#REF!
#REF!	Baseball & Softball	104	44	Changeup Baseball Pitching Machine M1450	JUGS	M1450	EACH	\$ 2,305.00	5.0%	\$ 115.25	\$ 2,189.75	+ shipping - see freight notes	#REF!
#REF!	Baseball & Softball	104	46	BP1 Combo Pitching Machine for baseball and softball M1501	JUGS	M1501	EACH	\$ 1,735.00	5.0%	\$ 86.75	\$ 1,648.25	+ shipping - see freight notes	#REF!
#REF!	Baseball & Softball	104	46	BP1—Baseball Only Pitching Machine M1401	JUGS	M1401	EACH	\$ 1,680.00	5.0%	\$ 84.00	\$ 1,596.00	+ shipping - see freight notes	#REF!
#REF!	Baseball & Softball	104	47	BP1 Softball Only Pitching Machine M1101	JUGS	M1101	EACH	\$ 1,670.00	5.0%	\$ 83.50	\$ 1,586.50	+ shipping - see freight notes	#REF!
#REF!	Baseball & Softball	104	47	BP1 Softball Only Pitching Machine With Transport cart M1106	JUGS	M1106	EACH	\$ 1,725.00	5.0%	\$ 86.25	\$ 1,638.75	+ shipping - see freight notes	#REF!
#REF!	Baseball & Softball	104	48	MVP Combo Pitching Machine for baseball and softball M1601	JUGS	M1601	EACH	\$ 1,140.00	5.0%	\$ 57.00	\$ 1,083.00	+ shipping - see freight notes	#REF!
#REF!	Baseball & Softball	104	49	The Combo Pitching Machine™ is 2 machines in 1—a baseball machine and a softball machine M1300	JUGS	M1300	EACH	\$ 3,905.00	5.0%	\$ 195.25	\$ 3,709.75	+ shipping - see freight notes	#REF!
#REF!	Baseball & Softball	104	50	Lite-Flite® Machine for baseball and softball M6000	JUGS	M6000	EACH	\$ 520.00	5.0%	\$ 26.00	\$ 494.00	+ shipping - see freight notes	#REF!
#REF!	Baseball & Softball	104	51	Small-Ball® Pitching Machine M7000	JUGS	M7000	EACH	\$ 290.00	5.0%	\$ 14.50	\$ 275.50	+ shipping - see freight notes	#REF!
#REF!	Baseball & Softball	104	52	P550™ Pitching Machine for baseball and softball M1150	JUGS	M1150	EACH	\$ 865.00	5.0%	\$ 43.25	\$ 821.75	+ shipping - see freight notes	#REF!
#REF!	Baseball & Softball	104	53	Toss™ Machine for baseball and softball A0600	JUGS	A0600	EACH	\$ 260.00	5.0%	\$ 13.00	\$ 247.00	+ shipping - see freight notes	#REF!
#REF!	Baseball & Softball	104	54	Automatic Ball Feeders - CAROUSEL FEEDER - 18-Softball Carousel Feeder: Works with all JUGS Softball machines past and present except the 2-wheel Combo. F1045	JUGS	F1045	EACH	\$ 605.00	5.0%	\$ 30.25	\$ 574.75	+ shipping - see freight notes	#REF!
#REF!	Baseball & Softball	104	54	Automatic Ball Feeders - CAROUSEL FEEDER - 36-Baseball Carousel Feeder: BP1 Baseball Only, Changeup Baseball, P550, Jr Baseball, MVP Baseball. F1050	JUGS	F1050	EACH	\$ 605.00	5.0%	\$ 30.25	\$ 574.75	+ shipping - see freight notes	#REF!
#REF!	Baseball & Softball	104	54	Automatic Ball Feeders - CAROUSEL FEEDER - 36-Baseball Carousel Feeder: BP3 F1065	JUGS	F1065	EACH	\$ 605.00	5.0%	\$ 30.25	\$ 574.75	+ shipping - see freight notes	#REF!
#REF!	Baseball & Softball	104	54	Automatic Ball Feeders - CAROUSEL FEEDER - 36-Baseball and 18-Softball Carousel Feeder: BP1 Combo, MVP Combo, Jr Baseball/Softball F1055	JUGS	F1055	EACH	\$ 650.00	5.0%	\$ 32.50	\$ 617.50	+ shipping - see freight notes	#REF!
#REF!	Baseball & Softball	104	55	14-Ball Lite-Flite Softball Feeder F1030	JUGS	F1030	EACH	\$ 260.00	5.0%	\$ 13.00	\$ 247.00	+ shipping - see freight notes	#REF!
#REF!	Baseball & Softball	104	55	18-Ball Lite-Flite Baseball Feeder F1025	JUGS	F1025	EACH	\$ 260.00	5.0%	\$ 13.00	\$ 247.00	+ shipping - see freight notes	#REF!
#REF!	Baseball & Softball	104	55	24-Ball Lite-Flite LaCrosse Feeder F1040	JUGS	F1040	EACH	\$ 260.00	5.0%	\$ 13.00	\$ 247.00	+ shipping - see freight notes	#REF!
#REF!	Baseball & Softball	104	55	14-Ball 2 Wheel Softball Feeder F1020	JUGS	F1020	EACH	\$ 690.00	5.0%	\$ 34.50	\$ 655.50	+ shipping - see freight notes	#REF!
#REF!	Baseball & Softball	104	55	18-Ball 2 Wheel Baseball Feeder F1000	JUGS	F1000	EACH	\$ 690.00	5.0%	\$ 34.50	\$ 655.50	+ shipping - see freight notes	#REF!
#REF!	Baseball & Softball	104	55	In-Line Feeder Remote Switch—Works with all JUGS Feeders F3000	JUGS	F3000	EACH	\$ 145.00	5.0%	\$ 7.25	\$ 137.75	+ shipping - see freight notes	#REF!

#REF!	Baseball & Softball	104	56	Ball Pouch A0020	JUGS	A0020	EACH	\$ 11.55	5.0%	\$ 0.58	\$ 10.97	+ shipping - see freight notes	#REF!
#REF!	Baseball & Softball	104	56	Back-Saver™ Ball Basket A1021	JUGS	A1021	EACH	\$ 71.50	5.0%	\$ 3.58	\$ 67.93	+ shipping - see freight notes	#REF!
#REF!	Baseball & Softball	104	56	Bucket Plus A1030	JUGS	A1030	EACH	\$ 52.00	5.0%	\$ 2.60	\$ 49.40	+ shipping - see freight notes	#REF!
#REF!	Baseball & Softball	104	56	Bucket with Lid: Albert Pujols A2030	JUGS	A2030	EACH	\$ 17.50	5.0%	\$ 0.88	\$ 16.63	+ shipping - see freight notes	#REF!
#REF!	Baseball & Softball	104	56	Bucket with Lid: Michele Smith A2031	JUGS	A2031	EACH	\$ 17.50	5.0%	\$ 0.88	\$ 16.63	+ shipping - see freight notes	#REF!
#REF!	Baseball & Softball	104	56	Portable Power Supplies: Yamaha®EF2000IS v2 Inverter Generator A2001	JUGS	A2001	EACH	\$ 1,250.00	5.0%	\$ 62.50	\$ 1,187.50	+ shipping - see freight notes	#REF!
#REF!	Baseball & Softball	104	56	Portable Power Supplies: Rechargeable Battery Pack A0050	JUGS	A0050	EACH	\$ 305.00	5.0%	\$ 15.25	\$ 289.75	+ shipping - see freight notes	#REF!
#REF!	Baseball & Softball	104	56	Portable Power Supplies: Complete Practice™ Battery Pack A0055	JUGS	A0055	EACH	\$ 1,030.00	5.0%	\$ 51.50	\$ 978.50	+ shipping - see freight notes	#REF!
#REF!	Baseball & Softball	104	56	JUGS Pitching Machine Cover A0015	JUGS	A0015	EACH	\$ 85.00	5.0%	\$ 4.25	\$ 80.75	+ shipping - see freight notes	#REF!
#REF!	Baseball & Softball	104	56	Softball Transport Cart A0702	JUGS	A0702	EACH	\$ 240.00	5.0%	\$ 12.00	\$ 228.00	+ shipping - see freight notes	#REF!
#REF!	Baseball & Softball	104	56	11-Inch Feed Chute 53025	JUGS	53025	EACH	\$ 50.00	5.0%	\$ 2.50	\$ 47.50	+ shipping - see freight notes	#REF!
#REF!	Baseball & Softball	104	56	Hitting Stick™ A1010	JUGS	A1010	EACH	\$ 28.00	5.0%	\$ 1.40	\$ 26.60	+ shipping - see freight notes	#REF!
#REF!	Baseball & Softball	104	56	Hitting Stick™ Package A1000	JUGS	A1000	PKG	\$ 47.00	5.0%	\$ 2.35	\$ 44.65	+ shipping - see freight notes	#REF!
#REF!	Baseball & Softball	104	56	Small-Ball™Instant Protective Screen 50200	JUGS	50200	EACH	\$ 85.00	5.0%	\$ 4.25	\$ 80.75	+ shipping - see freight notes	#REF!
#REF!	Baseball & Softball	104	57	JUGS Hitting Package - Albert Pujols Baseball Backyard Package™ A0001	JUGS	A0001	PKG	\$ 4,745.00	5.0%	\$ 237.25	\$ 4,507.75	+ shipping - see freight notes	#REF!
#REF!	Baseball & Softball	104	58	JUGS Hitting Package - Michelle Smith Softball Backyard Package™ A0002	JUGS	A0002	PKG	\$ 3,355.00	5.0%	\$ 167.75	\$ 3,187.25	+ shipping - see freight notes	#REF!
#REF!	Baseball & Softball	104	59	JUGS Hit at Home® Backyard Package - Baseball A0320	JUGS	A0320	PKG	\$ 1,975.00	5.0%	\$ 98.75	\$ 1,876.25	+ shipping - see freight notes	#REF!
#REF!	Baseball & Softball	104	59	JUGS Hit at Home® Backyard Package - Softball A0325	JUGS	A0325	PKG	\$ 1,945.00	5.0%	\$ 97.25	\$ 1,847.75	+ shipping - see freight notes	#REF!
#REF!	Baseball & Softball	104	60	JUGS Hitting Package - Youth League Package™ A0007	JUGS	A0007	PKG	\$ 3,735.00	5.0%	\$ 186.75	\$ 3,548.25	+ shipping - see freight notes	#REF!
#REF!	Baseball & Softball	104	61	JUGS Batting T Hitting Stations - JUGS® T Hitting Station - Baseball A0086	JUGS	A0086	PKG	\$ 425.00	5.0%	\$ 21.25	\$ 403.75	+ shipping - see freight notes	#REF!
#REF!	Baseball & Softball	104	61	JUGS Batting T Hitting Stations - JUGS® T Hitting Station - Softball A0096	JUGS	A0096	PKG	\$ 395.00	5.0%	\$ 19.75	\$ 375.25	+ shipping - see freight notes	#REF!
#REF!	Baseball & Softball	104	61	JUGS Batting T Hitting Stations - 5-Point Hitting Tee™ Package - Baseball A0110	JUGS	A0110	PKG	\$ 345.00	5.0%	\$ 17.25	\$ 327.75	+ shipping - see freight notes	#REF!
#REF!	Baseball & Softball	104	61	JUGS Batting T Hitting Stations - 5-Point Hitting Tee™ Package - Softball A0210	JUGS	A0210	PKG	\$ 360.00	5.0%	\$ 18.00	\$ 342.00	+ shipping - see freight notes	#REF!
#REF!	Baseball & Softball	104	61	JUGS Batting T Hitting Stations - Practice Package™ - Baseball A0100	JUGS	A0100	PKG	\$ 285.00	5.0%	\$ 14.25	\$ 270.75	+ shipping - see freight notes	#REF!
#REF!	Baseball & Softball	104	61	JUGS Batting T Hitting Stations - Practice Package™ - Softball A0200	JUGS	A0200	PKG	\$ 305.00	5.0%	\$ 15.25	\$ 289.75	+ shipping - see freight notes	#REF!
#REF!	Baseball & Softball	104	61	JUGS Batting T Hitting Stations - Toss Package™ - Baseball A0150	JUGS	A0150	PKG	\$ 480.00	5.0%	\$ 24.00	\$ 456.00	+ shipping - see freight notes	#REF!
#REF!	Baseball & Softball	104	61	JUGS Batting T Hitting Stations - Toss Package™ - Softball A0250	JUGS	A0250	PKG	\$ 480.00	5.0%	\$ 24.00	\$ 456.00	+ shipping - see freight notes	#REF!
#REF!	Baseball & Softball	104	62	JUGS Small-Ball® Pitching Machine Package A0060	JUGS	A0060	PKG	\$ 435.00	5.0%	\$ 21.75	\$ 413.25	+ shipping - see freight notes	#REF!
#REF!	Baseball & Softball	104	62	JUGS Short-Toss® Package A0008	JUGS	A0008	PKG	\$ 1,425.00	5.0%	\$ 71.25	\$ 1,353.75	+ shipping - see freight notes	#REF!
#REF!	Baseball & Softball	104	62	JUGS Baseball Backyard Net Package A0005	JUGS	A0005	PKG	\$ 1,800.00	5.0%	\$ 90.00	\$ 1,710.00	+ shipping - see freight notes	#REF!

#REF!	Baseball & Softball	104	62	JUGS Softball Backyard Net Package A0006	JUGS	A0006	PKG	\$ 1,755.00	5.0%	\$ 87.75	\$ 1,667.25	+ shipping - see freight notes	#REF!
#REF!	Baseball & Softball	104	63	Iron Mike Pitching Machine - HOPPER-FED PITCHING MACHINE - Model MP-6 #761-102	Iron Mike	761-102	EACH	\$ 4,650.00	5.0%	\$ 232.50	\$ 4,417.50	+ shipping - see freight notes	#REF!
#REF!	Baseball & Softball	104	63	Iron Mike Pitching Machine Accessory - POSITIVE FEED CONTROL UNIT FOR MP-6 #762-563	Iron Mike	762-563	EACH	\$ 215.00	5.0%	\$ 10.75	\$ 204.25	+ shipping - see freight notes	#REF!
#REF!	Baseball & Softball	104	63	Iron Mike Pitching Machine - HOPPER-FED PITCHING MACHINE - Model MP-4 #761-103	Iron Mike	761-103	EACH	\$ 5,195.00	5.0%	\$ 259.75	\$ 4,935.25	+ shipping - see freight notes	#REF!
#REF!	Baseball & Softball	104	63	Iron Mike Pitching Machine - RACK-FED PITCHING MACHINES - Model MP-5 #761-104	Iron Mike	761-104	EACH	\$ 3,895.00	5.0%	\$ 194.75	\$ 3,700.25	+ shipping - see freight notes	#REF!
#REF!	Baseball & Softball	104	63	Iron Mike Pitching Machine Accessory - Ball Feed Enhancer Unit #762-600	Iron Mike	762-600	EACH	\$ 155.00	5.0%	\$ 7.75	\$ 147.25	+ shipping - see freight notes	#REF!
#REF!	Baseball & Softball	104	64	Iron Mike Pitching Machine - STARTER MACHINE Model C-82 #762-006	Iron Mike	762-006	EACH	\$ 1,855.00	5.0%	\$ 92.75	\$ 1,762.25	+ shipping - see freight notes	#REF!
#REF!	Baseball & Softball	104	64	Iron Mike Pitching Machine - REMOTE CONTROL WITH 80' CORD #762-013	Iron Mike	762-013	EACH	\$ 180.00	5.0%	\$ 9.00	\$ 171.00	+ shipping - see freight notes	#REF!
#REF!	Baseball & Softball	104	64	Iron Mike Pitching Machine - Pitching Machine Cover C-53/MP-5 Cover #762-560	Iron Mike	762-560	EACH	\$ 235.00	5.0%	\$ 11.75	\$ 223.25	+ shipping - see freight notes	#REF!
#REF!	Baseball & Softball	104	64	Iron Mike Pitching Machine - Pitching Machine Cover C-55/MP-4/MP-6 Cover #762-561	Iron Mike	762-561	EACH	\$ 275.00	5.0%	\$ 13.75	\$ 261.25	+ shipping - see freight notes	#REF!
#REF!	Baseball & Softball	104	65	Pro Base Fungo Screens - 8'H X 8' W #BSFPRO8	Athletic Connection	#BSFPRO8	EACH	\$ 755.00	5.0%	\$ 37.75	\$ 717.25	+ shipping - see freight notes	#REF!
#REF!	Baseball & Softball	104	65	Replacement Net for above #1148596	Athletic Connection	#1148596	EACH	\$ 300.00	5.0%	\$ 15.00	\$ 285.00	+ shipping - see freight notes	#REF!
#REF!	Baseball & Softball	104	65	Pro Base Fungo Screens - 10'H x 10'W #BSFPRO10	Athletic Connection	#BSFPRO10	EACH	\$ 860.00	5.0%	\$ 43.00	\$ 817.00	+ shipping - see freight notes	#REF!
#REF!	Baseball & Softball	104	65	Replacement Net for above #1148619	Athletic Connection	#1148619	EACH	\$ 300.00	5.0%	\$ 15.00	\$ 285.00	+ shipping - see freight notes	#REF!
#REF!	Baseball & Softball	104	65	Professional L-Screen (Aluminum) #BSPROL	Athletic Connection	#BSPROL	EACH	\$ 775.00	5.0%	\$ 38.75	\$ 736.25	+ shipping - see freight notes	#REF!
#REF!	Baseball & Softball	104	65	Replacement Net for above #1148572	Athletic Connection	#1148572	EACH	\$ 300.00	5.0%	\$ 15.00	\$ 285.00	+ shipping - see freight notes	#REF!
#REF!	Baseball & Softball	104	65	Professional L-Screen (Steel) #BSPROLS	Athletic Connection	#BSPROLS	EACH	\$ 775.00	5.0%	\$ 38.75	\$ 736.25	+ shipping - see freight notes	#REF!
#REF!	Baseball & Softball	104	65	Tri-Fold Fungo Screen - Complete Unit #BSFRO16	Athletic Connection	#BSFRO16	UNIT	\$ 1,190.00	5.0%	\$ 59.50	\$ 1,130.50	+ shipping - see freight notes	#REF!
#REF!	Baseball & Softball	104	65	Tri-Fold Fungo Screen - Replacement Net-Middle Section #1148596	Athletic Connection	#1148596	EACH	\$ 300.00	5.0%	\$ 15.00	\$ 285.00	+ shipping - see freight notes	#REF!
#REF!	Baseball & Softball	104	65	Tri-Fold Fungo Screen - Replacement Net-Tri-Fold (sold in pairs) #1265279	Athletic Connection	#1265279	PAIR	\$ 319.00	5.0%	\$ 15.95	\$ 303.05	+ shipping - see freight notes	#REF!
#REF!	Baseball & Softball	104	66	Collegiate Protective Screens - Pitcher's Protector Complete Unit #1399586	Athletic Connection	#1399586	UNIT	\$ 280.00	5.0%	\$ 14.00	\$ 266.00	+ shipping - see freight notes	#REF!
#REF!	Baseball & Softball	104	66	Collegiate Protective Screens - Replacement Slip-On Net #BS47743NET	Athletic Connection	#BS47743NET	EACH	\$ 172.00	5.0%	\$ 8.60	\$ 163.40	+ shipping - see freight notes	#REF!
#REF!	Baseball & Softball	104	66	Collegiate Protective Screens - WHEEL KIT - #BSWKIT	Athletic Connection	#BSWKIT	EACH	\$ 88.00	5.0%	\$ 4.40	\$ 83.60		
#REF!	Baseball & Softball	104	66	Collegiate Protective Screens - Sock Net with Frame Complete Unit #1399597	Athletic Connection	#1399597	UNIT	\$ 365.00	5.0%	\$ 18.25	\$ 346.75	+ shipping - see freight notes	#REF!
#REF!	Baseball & Softball	104	66	Collegiate Protective Screens - Replacement Slip-On Net #BS47700NET	Athletic Connection	#BS47700NET	EACH	\$ 215.00	5.0%	\$ 10.75	\$ 204.25	+ shipping - see freight notes	#REF!
#REF!	Baseball & Softball	104	66	Collegiate Protective Screens - First Base/Fungo Protector Complete Unit #1399589	Athletic Connection	#1399589	UNIT	\$ 345.00	5.0%	\$ 17.25	\$ 327.75	+ shipping - see freight notes	#REF!
#REF!	Baseball & Softball	104	66	Collegiate Protective Screens - Replacement Slip-On Net #BS47710NET	Athletic Connection	#BS47710NET	EACH	\$ 150.00	5.0%	\$ 7.50	\$ 142.50	+ shipping - see freight notes	#REF!
#REF!	Baseball & Softball	104	66	Collegiate Protective Screens - Softball Pitcher Protector Complete Unit #1399588	Athletic Connection	#1399588	UNIT	\$ 325.00	5.0%	\$ 16.25	\$ 308.75	+ shipping - see freight notes	#REF!
#REF!	Baseball & Softball	104	66	Collegiate Protective Screens - Replacement Slip-On Net #BS47750NET	Athletic Connection	#BS47750NET	EACH	\$ 180.00	5.0%	\$ 9.00	\$ 171.00	+ shipping - see freight notes	#REF!
#REF!	Baseball & Softball	104	66	Net Repair Lacing Cord - 100' Spool—3mm #1236743	Athletic Connection	#1236743	SPOOL	\$ 21.50	5.0%	\$ 1.08	\$ 20.43	+ shipping - see freight notes	#REF!

#REF!	Baseball & Softball	104	66	C-Shaped Pitcher's Protector - 7'H X 7'W, 2.5 mm twisted knotted polyethylene slip-on net #1453177	Athletic Connection	1453177	EACH	\$ 280.00	5.0%	\$ 14.00	\$ 266.00	+ shipping - see freight notes	#REF!
#REF!	Baseball & Softball	104	66	C-Shaped Pitcher's Protector - Replacement Net #1366836N	Athletic Connection	1366836N	EACH	\$ 195.00	5.0%	\$ 9.75	\$ 185.25	+ shipping - see freight notes	#REF!
#REF!	Baseball & Softball	104	66	L-Screen W/Hood - 7'H X 7'W, 2.5 mm twisted knotted polyethylene slip-on net #1453178	Athletic Connection	1453178	EACH	\$ 360.00	5.0%	\$ 18.00	\$ 342.00	+ shipping - see freight notes	#REF!
#REF!	Baseball & Softball	104	66	L-Screen W/Hood - Replacement Net #1378703	Athletic Connection	1378703	EACH	\$ 180.00	5.0%	\$ 9.00	\$ 171.00	+ shipping - see freight notes	#REF!
#REF!	Baseball & Softball	104	66	Mini L Screen - Complete Unit #BSFPRO5	Athletic Connection	#BSFPRO5	UNIT	\$ 569.00	5.0%	\$ 28.45	\$ 540.55	+ shipping - see freight notes	#REF!
#REF!	Baseball & Softball	104	66	Mini L Screen - Replacement Net #1296464	Athletic Connection	#1296464	EACH	\$ 219.00	5.0%	\$ 10.95	\$ 208.05	+ shipping - see freight notes	#REF!
#REF!	Baseball & Softball	104	67	Hitting Station #BBHITSTA	Athletic Connection	#BBHITSTA	UNIT	\$ 745.00	5.0%	\$ 37.25	\$ 707.75	+ shipping - see freight notes	#REF!
#REF!	Baseball & Softball	104	67	Adjustable Field Ball Cart #1237207	Athletic Connection	#1237207	EACH	\$ 595.00	5.0%	\$ 29.75	\$ 565.25	+ shipping - see freight notes	#REF!
#REF!	Baseball & Softball	104	67	Batting Practice Ball Cart #1378683	Athletic Connection	#1378683	EACH	\$ 240.00	5.0%	\$ 12.00	\$ 228.00	+ shipping - see freight notes	#REF!
#REF!	Baseball & Softball	104	67	Replacement Wheel #1375102	Athletic Connection	#1375102	EACH	\$ 30.00	5.0%	\$ 1.50	\$ 28.50	+ shipping - see freight notes	#REF!
#REF!	Baseball & Softball	104	67	Foldable Ball Bin #1361841	Athletic Connection	#1361841	EACH	\$ 90.00	5.0%	\$ 4.50	\$ 85.50	+ shipping - see freight notes	#REF!
#REF!	Baseball & Softball	104	68	PROCAGE™ Professional Ball Cart #BPCADP	TSI	BPCADP	EACH	\$ 217.00	5.0%	\$ 10.85	\$ 206.15	+ shipping - see freight notes	#REF!
#REF!	Baseball & Softball	104	68	PROCAGE™ Professional Ball Cart Replacement Net #BPCADPN	TSI	BPCADPN	EACH	\$ 39.00	5.0%	\$ 1.95	\$ 37.05	+ shipping - see freight notes	#REF!
#REF!	Baseball & Softball	104	68	PROCAGE™ Batting Practice Ball Caddy #BPCAD	TSI	BPCAD	EACH	\$ 112.00	5.0%	\$ 5.60	\$ 106.40	+ shipping - see freight notes	#REF!
#REF!	Baseball & Softball	104	68	PROCAGE™ Batting Practice Ball Caddy Replacement Bag #BPCADMB	TSI	BPCADMB	EACH	\$ 30.50	5.0%	\$ 1.53	\$ 28.98	+ shipping - see freight notes	#REF!
#REF!	Baseball & Softball	104	68	Hanging Bat Rack #BHRACK	TSI	#BHRACK	EACH	\$ 35.00	5.0%	\$ 1.75	\$ 33.25	+ shipping - see freight notes	#REF!
#REF!	Baseball & Softball	104	68	Hanging Ball Holder - Baseballs #BBHLD	TSI	#BBHLD	EACH	\$ 25.00	5.0%	\$ 1.25	\$ 23.75	+ shipping - see freight notes	#REF!
#REF!	Baseball & Softball	104	68	Hanging Ball Holder - Softballs #SBHLD	TSI	#SBHLD	EACH	\$ 25.00	5.0%	\$ 1.25	\$ 23.75	+ shipping - see freight notes	#REF!
#REF!	Baseball & Softball	104	69	PROCAGE™ "OLE 96er" PRO L-SCREEN - Complete L-Screen #BLPRO96	TSI	BLPRO96	EACH	\$ 665.00	5.0%	\$ 33.25	\$ 631.75	+ shipping - see freight notes	#REF!
#REF!	Baseball & Softball	104	69	PROCAGE™ "OLE 96er" PRO L-SCREEN - Replacement L-Screen Net #BLPRO96N	TSI	BLPRO96N	EACH	\$ 170.00	5.0%	\$ 8.50	\$ 161.50	+ shipping - see freight notes	#REF!
#REF!	Baseball & Softball	104	69	PROCAGE™ "OLE 96er" PRO L-SCREEN - Frame Padding Kit #BPROPAD	TSI	BPROPAD	EACH	\$ 95.00	5.0%	\$ 4.75	\$ 90.25	+ shipping - see freight notes	#REF!
#REF!	Baseball & Softball	104	69	PROCAGE™ MINI PRO L-SCREEN - Complete Mini L-Screen #BLPRO57	TSI	BLPRO57	EACH	\$ 495.00	5.0%	\$ 24.75	\$ 470.25	+ shipping - see freight notes	#REF!
#REF!	Baseball & Softball	104	69	PROCAGE™ MINI PRO L-SCREEN - Replacement Mini L-Screen Net #BLPRO57N	TSI	BLPRO57N	EACH	\$ 135.00	5.0%	\$ 6.75	\$ 128.25	+ shipping - see freight notes	#REF!
#REF!	Baseball & Softball	104	69	PROCAGE™ "OLE 96er" FUNGO SCREEN - Complete Fungo Screen #BFPRO96	TSI	BFPRO96	EACH	\$ 680.00	5.0%	\$ 34.00	\$ 646.00	+ shipping - see freight notes	#REF!
#REF!	Baseball & Softball	104	69	PROCAGE™ "OLE 96er" FUNGO SCREEN - Replacement Fungo Net #BFPRO96N	TSI	BFPRO96N	EACH	\$ 180.00	5.0%	\$ 9.00	\$ 171.00	+ shipping - see freight notes	#REF!
#REF!	Baseball & Softball	104	69	PROCAGE™ "OLE 96er" FUNGO SCREEN - Frame Padding Kit #BPROPAD	TSI	BPROPAD	EACH	\$ 95.00	5.0%	\$ 4.75	\$ 90.25	+ shipping - see freight notes	#REF!
#REF!	Baseball & Softball	104	69	PROCAGE™ PROFESSIONAL 10' x 10' SCREEN - Complete Fungo Screen #BFPRO10	TSI	BFPRO10	EACH	\$ 730.00	5.0%	\$ 36.50	\$ 693.50	+ shipping - see freight notes	#REF!
#REF!	Baseball & Softball	104	69	PROCAGE™ PROFESSIONAL 10' x 10' SCREEN - Replacement Fungo Net #BFPRO10N	TSI	BFPRO10N	EACH	\$ 205.00	5.0%	\$ 10.25	\$ 194.75	+ shipping - see freight notes	#REF!
#REF!	Baseball & Softball	104	69	PROCAGE™ "OLE 96er" FUNGO SCREEN - Frame Padding Kit #BPROPAD	TSI	BPROPAD	EACH	\$ 95.00	5.0%	\$ 4.75	\$ 90.25	+ shipping - see freight notes	#REF!
#REF!	Baseball & Softball	104	70	PITCHER'S L-SCREEN PROTECTIVE SCREEN - Complete L-Screen #B607744	TSI	B607744	EACH	\$ 290.00	5.0%	\$ 14.50	\$ 275.50	+ shipping - see freight notes	#REF!



#REF!	Baseball & Softball	104	70	PITCHER'S L-SCREEN PROTECTIVE SCREEN - Replacement L-Screen Net #B607744N	TSI	B607744N	EACH	\$	155.00	5.0%	\$	7.75	\$	147.25	+ shipping - see freight notes	#REF!
#REF!	Baseball & Softball	104	70	PITCHER'S L-SCREEN PROTECTIVE SCREEN - Frame Padding Kit #B77PAD	TSI	B77PAD	EACH	\$	85.00	5.0%	\$	4.25	\$	80.75	+ shipping - see freight notes	#REF!
#REF!	Baseball & Softball	104	70	FIRST BASE/FUNGO PROTECTIVE SCREEN - Complete First Base/Fungo Screen #B607720	TSI	B607720	EACH	\$	280.00	5.0%	\$	14.00	\$	266.00	+ shipping - see freight notes	#REF!
#REF!	Baseball & Softball	104	70	FIRST BASE/FUNGO PROTECTIVE SCREEN - Replacement First Base/Fungo Net #B607720N	TSI	B607720N	EACH	\$	145.00	5.0%	\$	7.25	\$	137.75	+ shipping - see freight notes	#REF!
#REF!	Baseball & Softball	104	70	FIRST BASE/FUNGO PROTECTIVE SCREEN - Frame Padding Kit #B77PAD	TSI	B77PAD	EACH	\$	85.00	5.0%	\$	4.25	\$	80.75	+ shipping - see freight notes	#REF!
#REF!	Baseball & Softball	104	70	PROCAGE™ UNIVERSAL WHEEL KIT #BWHLKIT	TSI	BWHLKIT	EACH	\$	67.00	5.0%	\$	3.35	\$	63.65	+ shipping - see freight notes	#REF!
#REF!	Baseball & Softball	104	70	9-HOLE PITCHING TARGET/TRAINER #BPTRAIN9	TSI	BPTRAIN9	EACH	\$	255.00	5.0%	\$	12.75	\$	242.25	+ shipping - see freight notes	#REF!
#REF!	Baseball & Softball	104	70	9-HOLE PITCHING TARGET/TRAINER Replacement Net #BPTRAIN9N	TSI	BPTRAIN9N	EACH	\$	120.00	5.0%	\$	6.00	\$	114.00	+ shipping - see freight notes	#REF!
#REF!	Baseball & Softball	104	71	PITCHER'S L-SCREEN PROTECTIVE SCREEN - Complete L-Screen #B427744	TSI	B427744	EACH	\$	220.00	5.0%	\$	11.00	\$	209.00	+ shipping - see freight notes	#REF!
#REF!	Baseball & Softball	104	71	PITCHER'S L-SCREEN PROTECTIVE SCREEN - Replacement L-Screen Net #B427744N	TSI	B427744N	EACH	\$	105.00	5.0%	\$	5.25	\$	99.75	+ shipping - see freight notes	#REF!
#REF!	Baseball & Softball	104	71	PITCHER'S L-SCREEN PROTECTIVE SCREEN - Frame Padding Kit #B77PAD	TSI	B77PAD	EACH	\$	80.00	5.0%	\$	4.00	\$	76.00	+ shipping - see freight notes	#REF!
#REF!	Baseball & Softball	104	71	SOFTBALL PITCHER'S PROTECTIVE SCREEN - Complete Softball Pitcher's Screen #B427780	TSI	B427780	EACH	\$	220.00	5.0%	\$	11.00	\$	209.00	+ shipping - see freight notes	#REF!
#REF!	Baseball & Softball	104	71	SOFTBALL PITCHER'S PROTECTIVE SCREEN - Replacement Softball Pitcher's Screen Net #B427780N	TSI	B427780N	EACH	\$	105.00	5.0%	\$	5.25	\$	99.75	+ shipping - see freight notes	#REF!
#REF!	Baseball & Softball	104	71	SOFTBALL PITCHER'S PROTECTIVE SCREEN - Frame Padding Kit #B77PAD	TSI	B77PAD	EACH	\$	80.00	5.0%	\$	4.00	\$	76.00	+ shipping - see freight notes	#REF!
#REF!	Baseball & Softball	104	71	SOFTBALL PITCHER'S C-SCREEN PROTECTIVE SCREEN - Complete Softball Pitcher's C-Screen #B427790	TSI	B427790	EACH	\$	220.00	5.0%	\$	11.00	\$	209.00	+ shipping - see freight notes	#REF!
#REF!	Baseball & Softball	104	71	SOFTBALL PITCHER'S C-SCREEN PROTECTIVE SCREEN - Replacement C-Screen Net #B427790N	TSI	B427790N	EACH	\$	110.00	5.0%	\$	5.50	\$	104.50	+ shipping - see freight notes	#REF!
#REF!	Baseball & Softball	104	71	SOFTBALL PITCHER'S C-SCREEN PROTECTIVE SCREEN - Frame Padding Kit #B77PAD	TSI	B77PAD	EACH	\$	80.00	5.0%	\$	4.00	\$	76.00	+ shipping - see freight notes	#REF!
#REF!	Baseball & Softball	104	71	FIRST BASE/FUNGO PROTECTIVE SCREEN - Complete First Base/Fungo Screen #B427720	TSI	B427720	EACH	\$	220.00	5.0%	\$	11.00	\$	209.00	+ shipping - see freight notes	#REF!
#REF!	Baseball & Softball	104	71	FIRST BASE/FUNGO PROTECTIVE SCREEN - Replacement First Base/Fungo Net #B427720N	TSI	B427720N	EACH	\$	105.00	5.0%	\$	5.25	\$	99.75	+ shipping - see freight notes	#REF!
#REF!	Baseball & Softball	104	71	FIRST BASE/FUNGO PROTECTIVE SCREEN - Frame Padding Kit #B77PAD	TSI	B77PAD	EACH	\$	80.00	5.0%	\$	4.00	\$	76.00	+ shipping - see freight notes	#REF!
#REF!	Baseball & Softball	104	71	PROCAGE™ MINI FUNGO SCREEN - Complete Mini Fungo Screen #BSQ4274	TSI	BSQ4274	EACH	\$	185.00	5.0%	\$	9.25	\$	175.75	+ shipping - see freight notes	#REF!
#REF!	Baseball & Softball	104	71	PROCAGE™ MINI FUNGO SCREEN - Replacement Mini Fungo Net #BSQ4274N	TSI	BSQ4274N	EACH	\$	85.00	5.0%	\$	4.25	\$	80.75	+ shipping - see freight notes	#REF!
#REF!	Baseball & Softball	104	71	PROCAGE™ MINI FUNGO SCREEN - Frame Padding Kit #BSQ4274P	TSI	BSQ4274P	EACH	\$	80.00	5.0%	\$	4.00	\$	76.00	+ shipping - see freight notes	#REF!
#REF!	Baseball & Softball	104	71	SOFT TOSS/SOCK NET PROTECTIVE SCREEN - Complete Soft Toss/Sock Net Screen #B427700	TSI	B427700	EACH	\$	270.00	5.0%	\$	13.50	\$	256.50	+ shipping - see freight notes	#REF!
#REF!	Baseball & Softball	104	71	SOFT TOSS/SOCK NET PROTECTIVE SCREEN - Replacement Soft Toss/Sock Net #B427700N	TSI	B427700N	EACH	\$	120.00	5.0%	\$	6.00	\$	114.00	+ shipping - see freight notes	#REF!
#REF!	Baseball & Softball	104	71	SOFT TOSS/SOCK NET PROTECTIVE SCREEN - Frame Padding Kit #B77PAD	TSI	B77PAD	EACH	\$	80.00	5.0%	\$	4.00	\$	76.00	+ shipping - see freight notes	#REF!
#REF!	Baseball & Softball	104	72	PITCHER'S L-SCREEN PROTECTIVE SCREEN - Complete L-Screen #BSL77P	TSI	BSL77P	EACH	\$	155.00	5.0%	\$	7.75	\$	147.25	+ shipping - see freight notes	#REF!
#REF!	Baseball & Softball	104	72	PITCHER'S L-SCREEN PROTECTIVE SCREEN - Replacement L-Screen Net #B427744N	TSI	B427744N	EACH	\$	100.00	5.0%	\$	5.00	\$	95.00	+ shipping - see freight notes	#REF!
#REF!	Baseball & Softball	104	72	TRI-FOLD PROTECTIVE SCREEN - Complete Tri-Fold Screen #BTRIFLD	TSI	BTRIFLD	EACH	\$	305.00	5.0%	\$	15.25	\$	289.75	+ shipping - see freight notes	#REF!
#REF!	Baseball & Softball	104	72	TRI-FOLD PROTECTIVE SCREEN - Replacement Tri-Fold Net #BTRINET	TSI	BTRINET	EACH	\$	120.00	5.0%	\$	6.00	\$	114.00	+ shipping - see freight notes	#REF!

#REF!	Baseball & Softball	104	72	FIRST BASE/FUNGO PROTECTIVE SCREEN - Complete First Base/Fungo Screen #BSL77F	TSI	BSL77F	EACH	\$ 155.00	5.0%	\$ 7.75	\$ 147.25	+ shipping - see freight notes	#REF!
#REF!	Baseball & Softball	104	72	FIRST BASE/FUNGO PROTECTIVE SCREEN - Replacement First Base/Fungo Net #B427720N	TSI	B427720N	EACH	\$ 100.00	5.0%	\$ 5.00	\$ 95.00	+ shipping - see freight notes	#REF!
#REF!	Baseball & Softball	104	72	FIRST BASE/FUNGO PROTECTIVE SCREEN - 10' x 10' First Base/Fungo Screen #BSL10F	TSI	BSL10F	EACH	\$ 220.00	5.0%	\$ 11.00	\$ 209.00	+ shipping - see freight notes	#REF!
#REF!	Baseball & Softball	104	72	FIRST BASE/FUNGO PROTECTIVE SCREEN - Replacement First Base/Fungo Net #BSL10FN	TSI	BSL10FN	EACH	\$ 120.00	5.0%	\$ 6.00	\$ 114.00	+ shipping - see freight notes	#REF!
#REF!	Baseball & Softball	104	72	SOFTBALL PITCHER'S PROTECTIVE SCREEN - Complete Softball Pitcher's Screen #BSL775B	TSI	BSL775B	EACH	\$ 155.00	5.0%	\$ 7.75	\$ 147.25	+ shipping - see freight notes	#REF!
#REF!	Baseball & Softball	104	72	SOFTBALL PITCHER'S PROTECTIVE SCREEN - Replacement Softball Pitcher's Screen Net #B427780N	TSI	B427780N	EACH	\$ 100.00	5.0%	\$ 5.00	\$ 95.00	+ shipping - see freight notes	#REF!
#REF!	Baseball & Softball	104	72	SOFT TOSS/SOCK NET PROTECTIVE SCREEN - Complete Soft Toss/Sock Net Screen #BSL775	TSI	BSL775	EACH	\$ 185.00	5.0%	\$ 9.25	\$ 175.75	+ shipping - see freight notes	#REF!
#REF!	Baseball & Softball	104	72	SOFT TOSS/SOCK NET PROTECTIVE SCREEN - Replacement Soft Toss/Sock Net #B427700N	TSI	B427700N	EACH	\$ 100.00	5.0%	\$ 5.00	\$ 95.00	+ shipping - see freight notes	#REF!
#REF!	Baseball & Softball	104	73	Protector™ Series Replacement Netting - L-Shaped #S6050	JUGS	S6050	EACH	\$ 310.00	5.0%	\$ 15.50	\$ 294.50	+ shipping - see freight notes	#REF!
#REF!	Baseball & Softball	104	73	Protector™ Series Replacement Netting - Softball #S6065	JUGS	#S6065	EACH	\$ 310.00	5.0%	\$ 15.50	\$ 294.50	+ shipping - see freight notes	#REF!
#REF!	Baseball & Softball	104	73	Protector™ Series Replacement Netting - Square with Sock-Net™ #S6060	JUGS	#S6060	EACH	\$ 310.00	5.0%	\$ 15.50	\$ 294.50	+ shipping - see freight notes	#REF!
#REF!	Baseball & Softball	104	73	Protector™ Series Replacement Netting - Square Baseman #S6055	JUGS	#S6055	EACH	\$ 310.00	5.0%	\$ 15.50	\$ 294.50	+ shipping - see freight notes	#REF!
#REF!	Baseball & Softball	104	73	Protector™ Series Replacement Netting - Short-Toss® #S6070	JUGS	#S6070	EACH	\$ 275.00	5.0%	\$ 13.75	\$ 261.25	+ shipping - see freight notes	#REF!
#REF!	Baseball & Softball	104	73	Protector™ Series - L-Shaped Screen #S6000	JUGS	S6000	EACH	\$ 685.00	5.0%	\$ 34.25	\$ 650.75	+ shipping - see freight notes	#REF!
#REF!	Baseball & Softball	104	73	Protector™ Series - C-Shaped Softball Screen #S6016	JUGS	S6016	EACH	\$ 685.00	5.0%	\$ 34.25	\$ 650.75	+ shipping - see freight notes	#REF!
#REF!	Baseball & Softball	104	73	Protector™ Series - Square Baseman Screen #S6005	JUGS	S6005	EACH	\$ 685.00	5.0%	\$ 34.25	\$ 650.75	+ shipping - see freight notes	#REF!
#REF!	Baseball & Softball	104	73	Protector™ Series - Square Screen with Sock-Net™ #S6010	JUGS	S6010	EACH	\$ 685.00	5.0%	\$ 34.25	\$ 650.75	+ shipping - see freight notes	#REF!
#REF!	Baseball & Softball	104	73	Protector™ Series - Short-Toss® Screen #S6020	JUGS	S6020	EACH	\$ 685.00	5.0%	\$ 34.25	\$ 650.75	+ shipping - see freight notes	#REF!
#REF!	Baseball & Softball	104	74	Protector Series Wheel Kit #A0720	JUGS	A0720	KIT	\$ 170.00	5.0%	\$ 8.50	\$ 161.50	+ shipping - see freight notes	#REF!
#REF!	Baseball & Softball	104	75	Backyard Bullpen™ Package-Baseball #R2115	JUGS	R2115	EACH	\$ 800.00	5.0%	\$ 40.00	\$ 760.00	+ shipping - see freight notes	#REF!
#REF!	Baseball & Softball	104	75	Backyard Bullpen™ Package-Softball #R2120	JUGS	R2120	EACH	\$ 800.00	5.0%	\$ 40.00	\$ 760.00	+ shipping - see freight notes	#REF!
#REF!	Baseball & Softball	104	75	Backyard Bullpen™ Screen ONLY #S0400	JUGS	S0400	EACH	\$ 325.00	5.0%	\$ 16.25	\$ 308.75	+ shipping - see freight notes	#REF!
#REF!	Baseball & Softball	104	76	Pepper Rebound Screen #NB51	Champro	NB51	EACH	\$ 67.95	5.0%	\$ 3.40	\$ 64.55	Delivered prices to 48 contiguous states, min. order of \$100 waived for bid customers	#REF!
#REF!	Baseball & Softball	104	77	INFINITY REBOUND SCREEN - #NB26 - 72" X 42" 1 1/4" STEEL TUBE FRAME	Champro	NB26	EACH	\$ 58.95	5.0%	\$ 2.95	\$ 56.00	Delivered prices to 48 contiguous states, min. order of \$100 waived for bid customers	#REF!
#REF!	Baseball & Softball	104	77	INFINITY REBOUND SCREEN - #NB28 - 54" X 36" 1" STEEL TUBE FRAME	Champro	NB28	EACH	\$ 43.95	5.0%	\$ 2.20	\$ 41.75	Delivered prices to 48 contiguous states, min. order of \$100 waived for bid customers	#REF!
#REF!	Baseball & Softball	104	77	INFINITY REBOUND SCREEN - #NB26E - 72" X 42" BULK PACKAGED	Champro	NB26E	EACH	\$ 46.95	5.0%	\$ 2.35	\$ 44.60	Delivered prices to 48 contiguous states, min. order of \$100 waived for bid customers	#REF!
#REF!	Baseball & Softball	104	77	VIRTUAL CATCHER/REBOUNDER - #NB25 - 52" X 36"	Champro	NB25	EACH	\$ 55.95	5.0%	\$ 2.80	\$ 53.15	Delivered prices to 48 contiguous states, min. order of \$100 waived for bid customers	#REF!
#REF!	Baseball & Softball	104	77	VIRTUAL CATCHER/REBOUNDER - #NBBH - REPLACEMENT BUNGEE HOOKS - 10 PACK	Champro	NBBH	PACK	\$ 7.95	5.0%	\$ 0.40	\$ 7.55	Delivered prices to 48 contiguous states, min. order of \$100 waived for bid customers	#REF!
#REF!	Baseball & Softball	104	77	PITCHBACK #NB10 58" X 42"	Champro	NB10	EACH	\$ 53.95	5.0%	\$ 2.70	\$ 51.25	Delivered prices to 48 contiguous states, min. order of \$100 waived for bid customers	#REF!
#REF!	Baseball & Softball	104	77	REBOUND SCREEN #NB24	Champro	NB24	EACH	\$ 34.95	5.0%	\$ 1.75	\$ 33.20	Delivered prices to 48 contiguous states, min. order of \$100 waived for bid customers	#REF!

#REF!	Baseball & Softball	104	78	BRUTE INFIELD SCREEN 7' X 7' #NB185	Champro	NB185	EACH	\$ 209.95	5.0%	\$ 10.50	\$ 199.45	Delivered prices to 48 contiguous states, min. order of \$100 waived for bid customers	#REF!
#REF!	Baseball & Softball	104	78	BRUTE INFIELD SCREEN 7' X 7' REPLACEMENT SCREEN NB185RS	Champro	NB185RS	EACH	\$ 104.95	5.0%	\$ 5.25	\$ 99.70	Delivered prices to 48 contiguous states, min. order of \$100 waived for bid customers	#REF!
#REF!	Baseball & Softball	104	78	BRUTE PITCHER'S SAFETY SCREEN 7' X 7' #NB183	Champro	NB183	EACH	\$ 209.95	5.0%	\$ 10.50	\$ 199.45	Delivered prices to 48 contiguous states, min. order of \$100 waived for bid customers	#REF!
#REF!	Baseball & Softball	104	78	BRUTE PITCHER'S SAFETY SCREEN 7' X 7' REPLACEMENT SCREEN #NB183RS	Champro	NB183RS	EACH	\$ 104.95	5.0%	\$ 5.25	\$ 99.70	Delivered prices to 48 contiguous states, min. order of \$100 waived for bid customers	#REF!
#REF!	Baseball & Softball	104	78	BRUTE SOCK SCREEN 7' X 7' #NB187	Champro	NB187	EACH	\$ 223.95	5.0%	\$ 11.20	\$ 212.75	Delivered prices to 48 contiguous states, min. order of \$100 waived for bid customers	#REF!
#REF!	Baseball & Softball	104	78	BRUTE SOCK SCREEN 7' X 7' REPLACEMENT SCREEN #NB187RS	Champro	NB187RS	EACH	\$ 104.95	5.0%	\$ 5.25	\$ 99.70	Delivered prices to 48 contiguous states, min. order of \$100 waived for bid customers	#REF!
#REF!	Baseball & Softball	104	78	BRUTE "2" SCREEN 7' X 5' #NBZ	Champro	NBZ	EACH	\$ 181.95	5.0%	\$ 9.10	\$ 172.85	Delivered prices to 48 contiguous states, min. order of \$100 waived for bid customers	#REF!
#REF!	Baseball & Softball	104	78	BRUTE "2" SCREEN 7' X 5' REPLACEMENT SCREEN #NBZRS	Champro	NBZRS	EACH	\$ 90.95	5.0%	\$ 4.55	\$ 86.40	Delivered prices to 48 contiguous states, min. order of \$100 waived for bid customers	#REF!
#REF!	Baseball & Softball	104	80	MVP Portable Training Screen - 5' x 5' #NB32	Champro	NB32	EACH	\$ 67.95	5.0%	\$ 3.40	\$ 64.55	Delivered prices to 48 contiguous states, min. order of \$100 waived for bid customers	#REF!
#REF!	Baseball & Softball	104	80	MVP Portable Training Screen - 5' x 5' REPLACEMENT TZ3 TARGET #NB32R	Champro	NB32R	EACH	\$ 6.95	5.0%	\$ 0.35	\$ 6.60	Delivered prices to 48 contiguous states, min. order of \$100 waived for bid customers	#REF!
#REF!	Baseball & Softball	104	80	MVP Portable Training Screen - 7' X 7' #NB35	Champro	NB35	EACH	\$ 76.95	5.0%	\$ 3.85	\$ 73.10	Delivered prices to 48 contiguous states, min. order of \$100 waived for bid customers	#REF!
#REF!	Baseball & Softball	104	80	MVP Portable Training Screen - 7' X 7' REPLACEMENT TZ3 TARGET #NB35R	Champro	NB35R	EACH	\$ 6.95	5.0%	\$ 0.35	\$ 6.60	Delivered prices to 48 contiguous states, min. order of \$100 waived for bid customers	#REF!
#REF!	Baseball & Softball	104	80	MVP PORTABLE SOCK SCREEN - 5' x 5' #NB43	Champro	NB43	EACH	\$ 67.95	5.0%	\$ 3.40	\$ 64.55	Delivered prices to 48 contiguous states, min. order of \$100 waived for bid customers	#REF!
#REF!	Baseball & Softball	104	80	MVP PORTABLE SOCK SCREEN - 7' X 7' #NB44	Champro	NB44	EACH	\$ 76.95	5.0%	\$ 3.85	\$ 73.10	Delivered prices to 48 contiguous states, min. order of \$100 waived for bid customers	#REF!
#REF!	Baseball & Softball	104	80	MVP PORTABLE SOCK SCREEN - 7' X 7' BULK PACKAGED #NB44E	Champro	NB44E	EACH	\$ 69.95	5.0%	\$ 3.50	\$ 66.45	Delivered prices to 48 contiguous states, min. order of \$100 waived for bid customers	#REF!
#REF!	Baseball & Softball	104	80	MVP PORTABLE L SCREEN - 7' X 7' #NB42	Champro	NB42	EACH	\$ 76.95	5.0%	\$ 3.85	\$ 73.10	Delivered prices to 48 contiguous states, min. order of \$100 waived for bid customers	#REF!
#REF!	Baseball & Softball	104	80	MVP SOFTBALL PITCHER'S SCREEN - 7' X 7' #NB52	Champro	NB52	EACH	\$ 69.95	5.0%	\$ 3.50	\$ 66.45	Delivered prices to 48 contiguous states, min. order of \$100 waived for bid customers	#REF!
#REF!	Baseball & Softball	104	80	MVP PORTABLE BARRIER #NLB	Champro	NLB	EACH	\$ 102.95	5.0%	\$ 5.15	\$ 97.80	Delivered prices to 48 contiguous states, min. order of \$100 waived for bid customers	#REF!
#REF!	Baseball & Softball	104	82	Perfect Pitch™ Baseballs (15) #B5300	JUGS	B5300	PACK	\$ 80.95	5.0%	\$ 4.05	\$ 76.90	+ shipping - see freight notes	#REF!
#REF!	Baseball & Softball	104	82	Perfect Pitch™ Softballs (15) #B5310	JUGS	B5310	PACK	\$ 103.95	5.0%	\$ 5.20	\$ 98.75	+ shipping - see freight notes	#REF!
#REF!	Baseball & Softball	104	82	Sting-Free® Baseballs, realistic seam White #B3000	JUGS	B3000	DOZ	\$ 61.95	5.0%	\$ 3.10	\$ 58.85	+ shipping - see freight notes	#REF!
#REF!	Baseball & Softball	104	82	Sting-Free® Baseballs, dimpled-style—White #B1005	JUGS	B1005	DOZ	\$ 61.95	5.0%	\$ 3.10	\$ 58.85	+ shipping - see freight notes	#REF!
#REF!	Baseball & Softball	104	82	Sting-Free® Baseballs, dimpled-style—Optic Yellow #B1000	JUGS	B1000	DOZ	\$ 61.95	5.0%	\$ 3.10	\$ 58.85	+ shipping - see freight notes	#REF!
#REF!	Baseball & Softball	104	82	Sting-Free® Softballs Optic Game-Ball Yellow™ Dimpled #B2015	JUGS	B2015	DOZ	\$ 72.95	5.0%	\$ 3.65	\$ 69.30	+ shipping - see freight notes	#REF!
#REF!	Baseball & Softball	104	82	Sting-Free® Softballs Optic Game-Ball Yellow™ Seamed #B4015	JUGS	B4015	DOZ	\$ 72.95	5.0%	\$ 3.65	\$ 69.30	+ shipping - see freight notes	#REF!
#REF!	Baseball & Softball	104	82	11" Sting-Free® Softballs, dimpled-style Optic Game-Ball Yellow™ Dimpled #B2020	JUGS	B2020	DOZ	\$ 72.95	5.0%	\$ 3.65	\$ 69.30	+ shipping - see freight notes	#REF!
#REF!	Baseball & Softball	104	82	JUGS Pearl® Leather Baseballs #B5200	JUGS	B5200	DOZ	\$ 113.95	5.0%	\$ 5.70	\$ 108.25	+ shipping - see freight notes	#REF!
#REF!	Baseball & Softball	104	82	NEW JUGS LeatherLast™ Leather Softballs #B5250	JUGS	B5250	DOZ	\$ 146.95	5.0%	\$ 7.35	\$ 139.60	+ shipping - see freight notes	#REF!
#REF!	Baseball & Softball	104	82	Lite-Flite® Baseballs Optic Yellow #B5000	JUGS	B5000	DOZ	\$ 50.95	5.0%	\$ 2.55	\$ 48.40	+ shipping - see freight notes	#REF!
#REF!	Baseball & Softball	104	82	Lite-Flite® Softballs 12" Optic Game-Ball Yellow™ #B5005	JUGS	B5005	DOZ	\$ 61.95	5.0%	\$ 3.10	\$ 58.85	+ shipping - see freight notes	#REF!

#REF!	Baseball & Softball	104	82	Lite-Flite® Softballs 11" Optic Game-Ball Yellow™ #B5010	JUGS	B5010	DOZ	\$ 61.95	5.0%	\$ 3.10	\$ 58.85	+ shipping - see freight notes	#REF!
#REF!	Baseball & Softball	104	82	Softie® Genuine Leather Practice Baseballs White #B5100	JUGS	B5100	DOZ	\$ 106.95	5.0%	\$ 5.35	\$ 101.60	+ shipping - see freight notes	#REF!
#REF!	Baseball & Softball	104	82	Softie® Genuine Leather Practice Softballs 12" Optic Game-Ball Yellow™ #B5105	JUGS	B5105	DOZ	\$ 124.95	5.0%	\$ 6.25	\$ 118.70	+ shipping - see freight notes	#REF!
#REF!	Baseball & Softball	104	82	Softie® Genuine Leather Practice Softballs 11" Optic Game-Ball Yellow™ #B5110	JUGS	B5110	DOZ	\$ 124.95	5.0%	\$ 6.25	\$ 118.70	+ shipping - see freight notes	#REF!
#REF!	Baseball & Softball	104	82	JUGS BULLDOG™ Polyball Baseballs White #B6005	JUGS	B6005	DOZ	\$ 27.95	5.0%	\$ 1.40	\$ 26.55	+ shipping - see freight notes	#REF!
#REF!	Baseball & Softball	104	82	JUGS BULLDOG™ Polyball Baseballs Vision-Enhanced Yellow™ #B6010	JUGS	B6010	DOZ	\$ 27.95	5.0%	\$ 1.40	\$ 26.55	+ shipping - see freight notes	#REF!
#REF!	Baseball & Softball	104	82	JUGS BULLDOG™ Polyball Baseballs Bulk Box—100 Individual Balls—White #B6006	JUGS	B6006	BB	\$ 172.95	5.0%	\$ 8.65	\$ 164.30	+ shipping - see freight notes	#REF!
#REF!	Baseball & Softball	104	82	JUGS BULLDOG™ Polyball Baseballs Vision-Enhanced Yellow™ #B6011	JUGS	B6011	BB	\$ 172.95	5.0%	\$ 8.65	\$ 164.30	+ shipping - see freight notes	#REF!
#REF!	Baseball & Softball	104	82	JUGS BULLDOG™ Polyball Softballs Game-Ball Yellow™ #B7010	JUGS	B7010	DOZ	\$ 38.95	5.0%	\$ 1.95	\$ 37.00	+ shipping - see freight notes	#REF!
#REF!	Baseball & Softball	104	82	JUGS BULLDOG™ Polyball Softballs Bulk Box—84 Individual Balls—Game-Ball Yellow™ #B7011	JUGS	B7011	BB	\$ 206.95	5.0%	\$ 10.35	\$ 196.60	+ shipping - see freight notes	#REF!
#REF!	Baseball & Softball	104	82	Small-Ball® White #B5130	JUGS	B5130	DOZ	\$ 23.95	5.0%	\$ 1.20	\$ 22.75	+ shipping - see freight notes	#REF!
#REF!	Baseball & Softball	104	82	Small-Ball® Vision-Enhanced Yellow™ #B5132	JUGS	B5132	DOZ	\$ 23.95	5.0%	\$ 1.20	\$ 22.75	+ shipping - see freight notes	#REF!
#REF!	Baseball & Softball	104	82	Small-Ball® 25 DOZEN OR MORE White or Vision-Enhanced Yellow™ #B5130A	JUGS	B5130A	DOZ	\$ 21.95	5.0%	\$ 1.10	\$ 20.85	+ shipping - see freight notes	#REF!
#REF!	Baseball & Softball	104	82	JUGS Lacrosse Balls White #B1100	JUGS	B1100	DOZ	\$ 61.95	5.0%	\$ 3.10	\$ 58.85	+ shipping - see freight notes	#REF!
#REF!	Baseball & Softball	104	82	JUGS Lacrosse Balls Yellow #B1105	JUGS	B1105	DOZ	\$ 61.95	5.0%	\$ 3.10	\$ 58.85	+ shipping - see freight notes	#REF!
#REF!	Baseball & Softball	104	82	Bucket of JUGS Pearl® Baseballs— 4-Dozen Balls (Includes FREE Pujols Bucket with Lid) #B5210	JUGS	B5210	Bucket	\$ 456.00	5.0%	\$ 22.80	\$ 433.20	+ shipping - see freight notes	#REF!
#REF!	Baseball & Softball	104	82	NEW Bucket of JUGS LeatherLast™ Softballs— 2-Dozen Balls (Includes FREE Michele Smith Bucket with Lid) #B5260	JUGS	B5260	Bucket	\$ 291.00	5.0%	\$ 14.55	\$ 276.45	+ shipping - see freight notes	#REF!
#REF!	Baseball & Softball	104	82	Bucket of JUGS BULLDOG™ Baseballs—18 Balls Vision-Enhanced Yellow™ #B6012	JUGS	B6012	Bucket	\$ 57.00	5.0%	\$ 2.85	\$ 54.15	+ shipping - see freight notes	#REF!
#REF!	Baseball & Softball	104	82	Bucket of JUGS BULLDOG™ Baseballs—18 Balls White #B6007	JUGS	B6007	Bucket	\$ 57.00	5.0%	\$ 2.85	\$ 54.15	+ shipping - see freight notes	#REF!
#REF!	Baseball & Softball	104	82	Bucket of JUGS BULLDOG™ Softballs—12 Balls Game-Ball Yellow™ #B7012	JUGS	B7012	Bucket	\$ 57.00	5.0%	\$ 2.85	\$ 54.15	+ shipping - see freight notes	#REF!
#REF!	Baseball & Softball	104	82	Bucket of Lite-Flite® Baseballs—18 Balls Optic Yellow #B5001	JUGS	B5001	Bucket	\$ 84.95	5.0%	\$ 4.25	\$ 80.70	+ shipping - see freight notes	#REF!
#REF!	Baseball & Softball	104	82	Bucket of Lite-Flite® Softballs—12 Balls Optic Game-Ball Yellow™#B5006	JUGS	B5006	Bucket	\$ 84.95	5.0%	\$ 4.25	\$ 80.70	+ shipping - see freight notes	#REF!
#REF!	Baseball & Softball	104	82	Bucket of JUGS Small-Ball®— 4-Dozen Balls White #B5135	JUGS	B5135	Bucket	\$ 79.95	5.0%	\$ 4.00	\$ 75.95	+ shipping - see freight notes	#REF!
#REF!	Baseball & Softball	104	82	Bucket of JUGS Small-Ball®— 4-Dozen Balls Vision-Enhanced Yellow™ #B5140	JUGS	B5140	Bucket	\$ 79.95	5.0%	\$ 4.00	\$ 75.95	+ shipping - see freight notes	#REF!
#REF!	Baseball & Softball	104	83	BRUTE BATTING TEE #B080	Champro	B080	EACH	\$ 47.95	5.0%	\$ 2.40	\$ 45.55	Delivered prices to 48 contiguous states, min. order of \$100 waived for bid customers	#REF!
#REF!	Baseball & Softball	104	83	BRUTE BATTING TEE REPLACEMENT RUBBER TOP #B070R	Champro	B070R	EACH	\$ 4.95	5.0%	\$ 0.25	\$ 4.70	Delivered prices to 48 contiguous states, min. order of \$100 waived for bid customers	#REF!
#REF!	Baseball & Softball	104	83	EQUITEEE BATTING TEE #B060	Champro	B060	EACH	\$ 78.95	5.0%	\$ 3.95	\$ 75.00	Delivered prices to 48 contiguous states, min. order of \$100 waived for bid customers	#REF!
#REF!	Baseball & Softball	104	83	EQUITEEE BATTING TEE - REPLACEMENT BALL HOLDERS - 2 PACK #B061	Champro	B061	PACK	\$ 8.95	5.0%	\$ 0.45	\$ 8.50	Delivered prices to 48 contiguous states, min. order of \$100 waived for bid customers	#REF!
#REF!	Baseball & Softball	104	83	HEAVY-DUTY 5-POSITION TEE #B064	Champro	B064	EACH	\$ 37.95	5.0%	\$ 1.90	\$ 36.05	Delivered prices to 48 contiguous states, min. order of \$100 waived for bid customers	#REF!
#REF!	Baseball & Softball	104	84	ULTIMATE 3-IN-1 BATTING TEE #B069	Champro	B069	EACH	\$ 37.95	5.0%	\$ 1.90	\$ 36.05	Delivered prices to 48 contiguous states, min. order of \$100 waived for bid customers	#REF!

#REF!	Baseball & Softball	104	84	ULTIMATE 3-IN-1 BATTING TEE - REPLACEMENT BALL HOLDERS - 2 PACK #B069R	Champro	B069R	EACH	\$	9.95	5.0%	\$	0.50	\$	9.45	Delivered prices to 48 contiguous states, min. order of \$100 waived for bid customers	#REF!
#REF!	Baseball & Softball	104	84	5-POSITION TEE #B063	Champro	B063	EACH	\$	25.95	5.0%	\$	1.30	\$	24.65	Delivered prices to 48 contiguous states, min. order of \$100 waived for bid customers	#REF!
#REF!	Baseball & Softball	104	84	3-POSITION TEE #B062	Champro	B062	EACH	\$	19.95	5.0%	\$	1.00	\$	18.95	Delivered prices to 48 contiguous states, min. order of \$100 waived for bid customers	#REF!
#REF!	Baseball & Softball	104	85	MVP RUBBER BATTING TEE #B101	Champro	B101	EACH	\$	22.95	5.0%	\$	1.15	\$	21.80	Delivered prices to 48 contiguous states, min. order of \$100 waived for bid customers	#REF!
#REF!	Baseball & Softball	104	85	HEAVY-DUTY RUBBER BATTING TEE - INDIVIDUALLY RETAIL BOXED (WAFFLE BOTTOM) #B050I	Champro	B050I	EACH	\$	18.95	5.0%	\$	0.95	\$	18.00	Delivered prices to 48 contiguous states, min. order of \$100 waived for bid customers	#REF!
#REF!	Baseball & Softball	104	85	HEAVY-DUTY RUBBER BATTING TEE - TOP RUBBER REPLEMNT TUBE #B054	Champro	B054	EACH	\$	6.95	5.0%	\$	0.35	\$	6.60	Delivered prices to 48 contiguous states, min. order of \$100 waived for bid customers	#REF!
#REF!	Baseball & Softball	104	85	PRO-GRADE FOLDING BATTING TEE #B070	Champro	B070	EACH	\$	22.95	5.0%	\$	1.15	\$	21.80	Delivered prices to 48 contiguous states, min. order of \$100 waived for bid customers	#REF!
#REF!	Baseball & Softball	104	85	PRO-GRADE FOLDING BATTING TEE - REPLACEMENT RUBBER TOP #B070R	Champro	B070R	EACH	\$	4.95	5.0%	\$	0.25	\$	4.70	Delivered prices to 48 contiguous states, min. order of \$100 waived for bid customers	#REF!
#REF!	Baseball & Softball	104	85	PORTABLE LIGHTWEIGHT BATTING TEE #B066	Champro	B066	EACH	\$	21.95	5.0%	\$	1.10	\$	20.85	Delivered prices to 48 contiguous states, min. order of \$100 waived for bid customers	#REF!
#REF!	Baseball & Softball	104	85	HIGH IMPACT TEE ONLY #B051	Champro	B051	EACH	\$	13.95	5.0%	\$	0.70	\$	13.25	Delivered prices to 48 contiguous states, min. order of \$100 waived for bid customers	#REF!
#REF!	Baseball & Softball	104	85	BRUSH TOP TEE ADAPTER #B068-AD	Champro	B068-AD	EACH	\$	6.95	5.0%	\$	0.35	\$	6.60	Delivered prices to 48 contiguous states, min. order of \$100 waived for bid customers	#REF!
#REF!	Baseball & Softball	104	86	JUGS® T #A0415	JUGS	A0415	EACH	\$	108.95	5.0%	\$	5.45	\$	103.50	+ shipping - see freight notes	#REF!
#REF!	Baseball & Softball	104	86	JUGS® Short T #A0416	JUGS	A0416	EACH	\$	96.95	5.0%	\$	4.85	\$	92.10	+ shipping - see freight notes	#REF!
#REF!	Baseball & Softball	104	86	JUGS® Combo T Package #A0417	JUGS	A0417	EACH	\$	159.95	5.0%	\$	8.00	\$	151.95	+ shipping - see freight notes	#REF!
#REF!	Baseball & Softball	104	87	Hit Like a Pro Hitting Tee™ #A0400	JUGS	A0400	EACH	\$	37.00	5.0%	\$	1.85	\$	35.15	+ shipping - see freight notes	#REF!
#REF!	Baseball & Softball	104	87	5-Point Hitting Tee™ #A0410	JUGS	A0410	EACH	\$	103.00	5.0%	\$	5.15	\$	97.85	+ shipping - see freight notes	#REF!
#REF!	Baseball & Softball	104	88	BATTING TUNNEL TURF - 24 oz. polypropylene pile, 12' wide, pine green, 5 mm foam, Custom Size #357245F12	GrassTex	357245F12	SF	\$	3.25	5.0%	\$	0.16	\$	3.09	+ shipping - see freight notes	#REF!
#REF!	Baseball & Softball	104	88	BATTING TUNNEL TURF - 24 oz. polypropylene pile, 12' wide, pine green, 5 mm foam, 12' wide by 55 long roll #357245F1255	GrassTex	#357245F1255	ROLL	\$	2,145.00	5.0%	\$	107.25	\$	2,037.75	+ shipping - see freight notes	#REF!
#REF!	Baseball & Softball	104	88	BATTING TUNNEL TURF - 24 oz. polypropylene pile, 12' wide, pine green, 5 mm foam, 12' wide by 70 long roll #357245F1270	GrassTex	#357245F1270	ROLL	\$	2,730.00	5.0%	\$	0.05	\$	2,729.95	+ shipping - see freight notes	#REF!
#REF!	Baseball & Softball	104	88	BATTING TUNNEL TURF - 24 oz. polypropylene pile, 12' wide, pine green, 3 mm foam, Custom Size #357243F12	GrassTex	#357243F12	SF	\$	2.85	5.0%	\$	0.14	\$	2.71	+ shipping - see freight notes	#REF!
#REF!	Baseball & Softball	104	88	BATTING TUNNEL TURF - 24 oz. polypropylene pile, 12' wide, pine green, 3 mm foam, 12' wide x 55 long roll #357243F1255	GrassTex	#357243F1255	ROLL	\$	1,881.00	5.0%	\$	94.05	\$	1,786.95	+ shipping - see freight notes	#REF!
#REF!	Baseball & Softball	104	88	BATTING TUNNEL TURF - 24 oz. polypropylene pile, 12' wide, pine green, 3 mm foam, 12' wide x 70 long roll #357243F1270	GrassTex	#357243F1270	ROLL	\$	2,394.00	5.0%	\$	119.70	\$	2,274.30	+ shipping - see freight notes	#REF!
#REF!	Baseball & Softball	104	88	BATTING TUNNEL TURF - 24 oz. polypropylene pile, 12' wide, pine green, SilverBack polyurethane, Custom Size #357245B12	GrassTex	#357245B12	SF	\$	2.10	5.0%	\$	0.11	\$	2.00	+ shipping - see freight notes	#REF!
#REF!	Baseball & Softball	104	88	BATTING TUNNEL TURF - 24 oz. polypropylene pile, 12' wide, pine green, SilverBack polyurethane, 12' wide x 55 long roll #357245B1255	GrassTex	#357245B1255	ROLL	\$	1,386.00	5.0%	\$	69.30	\$	1,316.70	+ shipping - see freight notes	#REF!
#REF!	Baseball & Softball	104	88	BATTING TUNNEL TURF - 24 oz. polypropylene pile, 12' wide, pine green, SilverBack polyurethane, 12' wide x 70 long roll #357245B1270	GrassTex	#357245B1270	ROLL	\$	1,764.00	5.0%	\$	88.20	\$	1,675.80	+ shipping - see freight notes	#REF!
#REF!	Baseball & Softball	104	88	BATTING TUNNEL TURF - 36 oz. polyethylene/polypropylene blend 15' wide, field/lime green, 3 mm foam, Custom Size	GrassTex	#17736F15	SF	\$	2.85	5.0%	\$	0.14	\$	2.71	+ shipping - see freight notes	#REF!
#REF!	Baseball & Softball	104	88	BATTING TUNNEL TURF - 36 oz. polyethylene/polypropylene blend 15' wide, field/lime green, 3 mm foam, 15' wide x 55'L Roll	GrassTex	#17736F1555	ROLL	\$	2,351.00	5.0%	\$	117.55	\$	2,233.45	+ shipping - see freight notes	#REF!
#REF!	Baseball & Softball	104	88	BATTING TUNNEL TURF - 36 oz. polyethylene/polypropylene blend 15' wide, field/lime green, 3 mm foam, 15' wide x 70'L Roll	GrassTex	#17736F1570	ROLL	\$	2,992.50	5.0%	\$	149.63	\$	2,842.88	+ shipping - see freight notes	#REF!
#REF!	Baseball & Softball	104	88	Pre-Trim or Splitting Rolls - 49' roll and under	GrassTex	#CPTCUT1	EACH	\$	53.00	5.0%	\$	2.65	\$	50.35	+ shipping - see freight notes	#REF!
#REF!	Baseball & Softball	104	88	Pre-Trim or Splitting Rolls - 50' roll and over	GrassTex	#CPTCUT2	EACH	\$	106.00	5.0%	\$	5.30	\$	100.70	+ shipping - see freight notes	#REF!

#REF!	Baseball & Softball	104	88	Reverse Rolling Synthetic Turf	GrassTex	#RVRL	EACH	\$ 53.00	5.0%	\$ 2.65	\$ 50.35	+ shipping - see freight notes	#REF!
#REF!	Baseball & Softball	104	VAR	Cutting Charge - #CPTCUT	GrassTex	CPTCUT	EACH	\$ 50.00	5.0%	\$ 2.50	\$ 47.50	+ shipping - see freight notes	#REF!
#REF!	Baseball & Softball	104	VAR	Trimming Charge - CPTTRIM	GrassTex	CPTTRIM	EACH	\$ 50.00	5.0%	\$ 2.50	\$ 47.50	+ shipping - see freight notes	#REF!